



User Guide

AX1800 Dual-Band Wi-Fi 6 VDSL/ADSL
Modem Router

Contents

About This Guide	1
Chapter 1. Get to Know About Your Modem Router	3
1. 1. Product Overview.....	4
1. 2. Appearance	4
1. 2. 1.Top Panel	4
1. 2. 2.The Back Panel.....	6
Chapter 2. Connect the Hardware	8
2. 1. Position Your Modem Router	9
2. 2. Connect Your Modem Router	9
Chapter 3. Log In to Your Modem Router	13
Chapter 4. Set Up Internet Connection	15
4. 1. Use Quick Setup Wizard	16
4. 2. Quick Setup Via TP-Link Aginet App	17
4. 3. Manually Set Up Your Internet Connection	18
4. 3. 1.Set Up Internet Connection in DSL Modem Router Mode	18
4. 3. 2.Set Up Internet Connection in EWAN Router Mode.....	18
4. 4. Test Internet Connectivity	19
4. 5. Set Up an IPv6 Internet Connection	20
4. 5. 1.Set Up Internet Connection in DSL Modem Router Mode	20
4. 5. 2.Set Up Internet Connection in EWAN Router Mode.....	21
4. 6. IPv6 Tunnel.....	22
Chapter 5. VoIP	25
5. 1. Connecting the Telephone.....	26
5. 2. Entering Telephone Information.....	26
5. 3. Telephone Book	28
5. 3. 1.Telephone Book.....	28
5. 3. 2.Emergency Calls	29
5. 4. Telephony Devices Management.....	30
5. 5. Call Log	32
5. 6. Call Rules.....	32

5.7.	Call Blocks.....	33
5.7.1.	Do Not Disturb	33
5.7.2.	Blocking Certain Calls.....	34
5.7.3.	Prevent from Dialing.....	34
5.8.	Call Forwarding.....	35
5.9.	Voice Mail Settings	37

Chapter 6. Customize Your Network Settings..... 38

6.1.	Configure LAN Settings.....	39
6.1.1.	Change the LAN IP Address	39
6.1.2.	Use the Router as a DHCP Server.....	40
6.1.3.	Client List	41
6.1.4.	Reserve LAN IP Addresses	41
6.1.5.	Condition Pool	42
6.2.	Configure IPv6 LAN Settings.....	43
6.2.1.	Configure the RADVD Address Type.....	43
6.2.2.	Configure the DHCPv6 Server Address Type	44
6.3.	Configure DSL Settings.....	45
6.4.	Set Up a Dynamic DNS Service Account	45
6.5.	Create Static Routes.....	46
6.6.	RIP Settings	49
6.7.	Specify Wireless Settings.....	50
6.7.1.	Change Basic Wireless Settings	50
6.7.2.	Advanced Wireless Settings.....	52
6.7.3.	View Wireless Information.....	55
6.8.	Schedule Your Wireless Function	56
6.9.	Use WPS for Wireless Connection	57
6.10.	Configure MAC Filter Settings.....	59

Chapter 7. Multi-SSID 62

Chapter 8. TP-Link Cloud Service 64

8.1.	Register a TP-Link ID.....	65
8.2.	Change Your TP-Link ID Information.....	65
8.3.	Manage the User TP-Link IDs	66
8.3.1.	Add TP-Link ID to Manage the Modem Router.....	67
8.3.2.	Remove TP-Link ID(s) from Managing the Modem Router.....	67
8.4.	Manage the Modem Router via the TP-Link Aginet App.....	68

Chapter 9. USB Settings.....	69
9. 1. Access the USB Storage Device	70
9. 1. 1.Access the USB Device Locally.....	70
9. 1. 2.Access the USB Device Remotely	71
9. 1. 3.Customize the Access Settings.....	73
9. 2. Media Sharing	75
9. 3. 3G/4G Settings	76
Chapter 10.EasyMesh with Seamless Roaming.....	78
10. 1. Set Up a EasyMesh Network	79
10. 2. Manage Devices in the EasyMesh Network.....	81
Chapter 11.Guest Network.....	83
11. 1. Create a Network for Guests	84
11. 2. Customize Guest Network Options.....	84
Chapter 12.NAT Forwarding.....	86
12. 1. ALG	87
12. 2. Set Up Public Services on The Local Network by Virtual Servers.....	87
12. 3. Open Ports Dynamically by Port Triggering.....	89
12. 4. Make Applications Free from Port Restriction by DMZ	91
12. 5. Make Xbox Online Games Run Smoothly by UPnP	92
Chapter 13.Parental Controls	94
Chapter 14.Quality of Service.....	99
14. 1. Set up QoS for the network	100
14. 2. Configure Queue Settings	101
14. 3. Configure Flow Classification	102
Chapter 15.Network Security	104
15. 1. Firewall & DoS Protection	105
15. 2. Service Filtering	106
15. 3. Access Control	107
15. 4. IP & MAC Binding	109
15. 5. IPv6 Firewall	111
Chapter 16.VPN Server&Client.....	113

16. 1. Use OpenVPN to Access Your Home Network.....	114
16. 2. Use PPTP VPN to Access Your Home Network	115
16. 3. Use IPSec VPN to Access Your Home Network	119
16. 4. VPN Connections.....	128

Chapter 17.Manage Your Modem Router 129

17. 1. Set System Time	130
17. 2. Control the LED.....	131
17. 3. Test Internet Connectivity	131
17. 4. Update the Firmware.....	133
17. 5. Back Up and Restore Configuration Settings	134
17. 6. Reboot the Modem Router	135
17. 7. Administration Management.....	136
17. 7. 1.Change the Login Password.....	136
17. 7. 2.Local Management	136
17. 7. 3.Remote Management	137
17. 7. 4.HTTP Referer Head Check	138
17. 7. 5.ICMP Ping	139
17. 7. 6.Session ID	139
17. 8. System Log.....	140
17. 9. CWMP Settings.....	141
17. 10. SNMP Settings	143
17. 11. Monitor the Internet Traffic Statistics.....	144
17. 12. Port Mirror.....	145
17. 13. Session Timeout.....	145

FAQ 147





About This Guide

This guide is a complement of Quick Installation Guide. The Quick Installation Guide instructs you on quick internet setup, and this guide provides details of each function and shows you the way to configure these functions appropriate to your needs.

Note: Features available in the router may vary by model and software version. Router availability may also vary by region or ISP. All images, steps, and descriptions in this guide are only examples and may not reflect your actual Router experience.

Conventions

In this guide the following conventions are used:

Convention	Description
<u>Underlined</u>	Underlined words or phrases are hyperlinks. You can click to redirect to a website or a specific section.
Teal	Contents to be emphasized and texts on the web page are in teal, including the menus, items, buttons, etc.
>	The menu structures to show the path to load the corresponding page. For example, Advanced > Wireless > WDS means the WDS function page is under the Wireless menu that is located in the Advanced tab.
Note:	Ignoring this type of note might result in a malfunction or damage to the device.
Tips:	Indicates important information that helps you make better use of your device.
symbols on the web page	<ul style="list-style-type: none">•  Click to edit the corresponding entry.•  Click to delete the corresponding entry.•  click to enable or disable the corresponding entry.•  Click to view more information about items on the page.

More Info

The latest software, management app and utility can be found at [Download Center](https://www.tp-link.com/support/download/) at <https://www.tp-link.com/support/download/>.

The Quick Installation Guide can be found where you find this guide or inside the package of the router.

Specifications can be found on the product page at <https://www.tp-link.com>.

TP-Link Community is provided for you to discuss our products and share knowledge at <https://community.tp-link.com>.

Our Technical Support contact information can be found at the [Contact Technical Support](https://www.tp-link.com/support/) page at <https://www.tp-link.com/support/>.

*Maximum wireless signal rates are the physical rates derived from IEEE Standard 802.11 specifications. Actual wireless data throughput and wireless coverage are not guaranteed and will vary as a result of 1) environmental factors, including building materials, physical objects, and obstacles, 2) network conditions, including local interference, volume and density of traffic, product location, network complexity, and network overhead, and 3) client limitations, including rated performance, location, connection, quality, and client condition.

*Use of Wi-Fi 6 (802.11ax), and features including OFDMA, MU-MIMO, 1024-QAM, and HT160 require clients to also support the corresponding features.

*Saving clients' battery power requires clients to also support the 802.11ax Wi-Fi standard. Actual power reduction may vary as a result of network conditions, client limitations, and environmental factors.

*Use of WPA3 requires clients to also support the corresponding feature.

*This router may not support all the mandatory features as ratified in Draft 3.0 of IEEE 802.11ax specification.

*Further software upgrades for feature availability may be required.

Chapter 1

Get to Know About Your Modem Router

This chapter introduces what the modem router can do and shows its appearance.

It chapter contains the following sections:

- [Product Overview](#)
- [Appearance](#)

1.1. Product Overview

TP-Link's Modem Router is a combined wired/wireless network connection device with integrated EWAN router and DSL modem router, reducing hassle of configuration and saving space.

With Ethernet ports and antennas, the modem router provides wired and wireless access for multiple computers and mobile devices.

With various features and functions, the modem router is the perfect hub of your home or business network.

Moreover, it is simple and convenient to set up and use the TP-Link router due to its intuitive web interface and the powerful Aginet app.

Note: The appearance of the product is for illustration only, it may be different from your device, please refer to the actual product.









1.2. Appearance

1.2.1. Top Panel



The modem router's LEDs (view from left to right) are located on the front. You can check the modem router's working status by following the LED Explanation table.

Some Common LEDs Explanation

LED	Status	Indication
 (Power)	On	The system has started up successfully.
	Flashing	The system is starting up or the firmware is being upgraded. Do not disconnect or power off your router.
	Off	Power is off.
 (DSL)	On	DSL synchronization is complete.
	Flashing	DSL synchronization is in progress.
	Off	DSL synchronization failed.
 (Internet)	On	Internet service is available.
	Off	The router's WAN port is unplugged.
 (2.4GHz Wireless)	On	The 2.4GHz wireless band is enabled.
	Flashing	The router is transmitting or receiving data via 2.4GHz band.
	Off	The 2.4GHz wireless band is disabled.
 (5GHz Wireless)	On	The 5GHz wireless band is enabled.
	Flashing	The router is transmitting or receiving data via 5GHz band.
	Off	The 5GHz wireless band is disabled.
 (WPS)	On/Off	Turns on when a WPS synchronization is established and automatically turns off about 5 minutes later.
	Flashing	A wireless device is trying to connect to the network via WPS. This process may take up to 2 minutes.
 (WAN)	On	A device is connected to the WAN port.
	Flashing	The WAN port is sending or receiving data.
	Off	No device is connected to the WAN port.
 (LAN)	On	A device is connected to the LAN port.
	Flashing	The LAN port is sending or receiving data.
	Off	No device is connected to the LAN port.
 (PHONE)	On	The SIP account is registered successfully.
	Flashing Slowly	The phone is on-hook and there are voice messages.
	Flashing Quickly	The phone is ringing.
	Off	No SIP account is registered.

Some Common LEDs Explanation

LED	Status	Indication
🔌 (USB)	On	The USB device is identified and ready to use.
	Flashing	A new USB device is being identified, or data is being transferred.
	Off	No USB device is plugged in to the USB port.

Note:

1. If the DSL LED is off, please check your Internet connection first. Refer to [Connect the Hardware](#) for more information about how to make Internet connection correctly. If you have already made a right connection, please contact your ISP to make sure your Internet service is available now.
2. If the Internet LED is off, please check your DSL LED first. If your DSL LED is also off, please refer to [Note 1](#). If your DSL LED is ON, please check your Internet configuration. You may need to check this part of information with your ISP and make sure everything have been input correctly.
3. If the 4G LED is off, please check your Internet LED first. If the Internet LED is also off, please check your internet connection. If you have already made a right connection, please contact your ISP to make sure your 4G network service is available.

1.2.2. The Back Panel

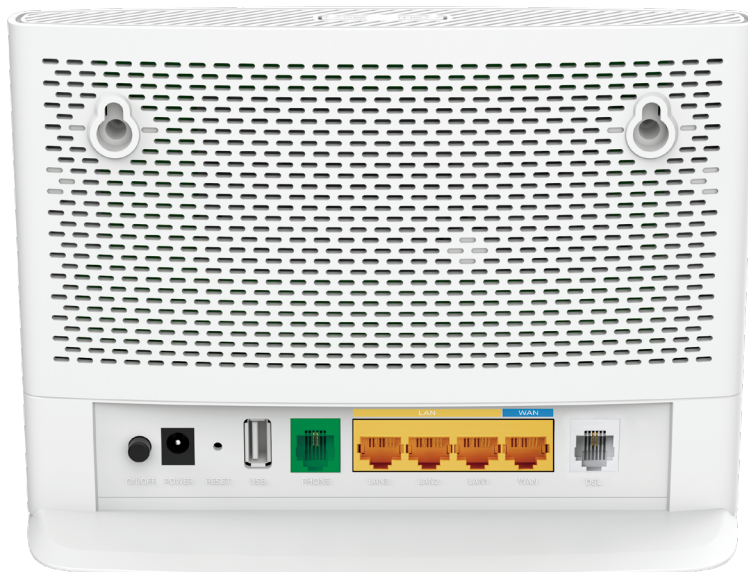

The following parts (view from left to right) are located on the back panel.

Some Common Buttons and Ports Explanation

Item	Description
DSL	For connecting the modem router to the Internet. Connect the port to the splitter or directly connect the port to the phone jack via a phone cable. For details, please refer to Get to Know About Your Modem Router .

Item	Description
LAN1, LAN2, LAN3, WAN Ports	For connecting the modem router to your PC or other Ethernet network devices. In wireless router mode, the WAN port is used for connecting to a Cable/FTTH/VDSL/ADSL device.
Phone	For connecting your analog phone to the modem router. Note that you can only connect to two ports (one to a Phone1 and the other to a Phone2) at most.
POWER	For connecting the modem router to power socket via the provided power adapter.
USB Port	For connecting to a USB storage device.
ON/OFF	The switch for the power. Press it to power on or off the modem router.
RESET	Press and hold this button for at least 5 seconds until all LEDs blink to reset the router to its factory default settings.
WiFi	Press the button to turn both 2.4GHz and 5GHz Wi-Fi on or off.
WPS	Press the button to start a WPS synchronization.

Chapter 2

Connect the Hardware

This chapter contains the following sections:

- [Position Your Modem Router](#)
- [Connect Your Modem Router](#)

2.1. Position Your Modem Router

With the modem router, you can access your network from anywhere within the wireless network coverage. However, the wireless signal strength and coverage varies depending on the actual environment where your modem router is in. Many obstacles may limit the range of the wireless signal, for example, concrete structures, thick walls.

For your security and best Wi-Fi performance, please:

- Do Not locate the modem router in the place where it will be exposed to moisture or excessive heat.
- Keep away from the strong electromagnetic radiation and the device of electromagnetic sensitive.
- Place the modem router in a location where it can be connected to the various devices as well as to a power source.
- Make sure the cables and power cord are safely placed out of the way so they do not create a tripping hazard.

 **Tips:** The modem router can be placed on a shelf or desktop.

Generally, VX230v is placed on a horizontal surface. The device also can be mounted on the wall.

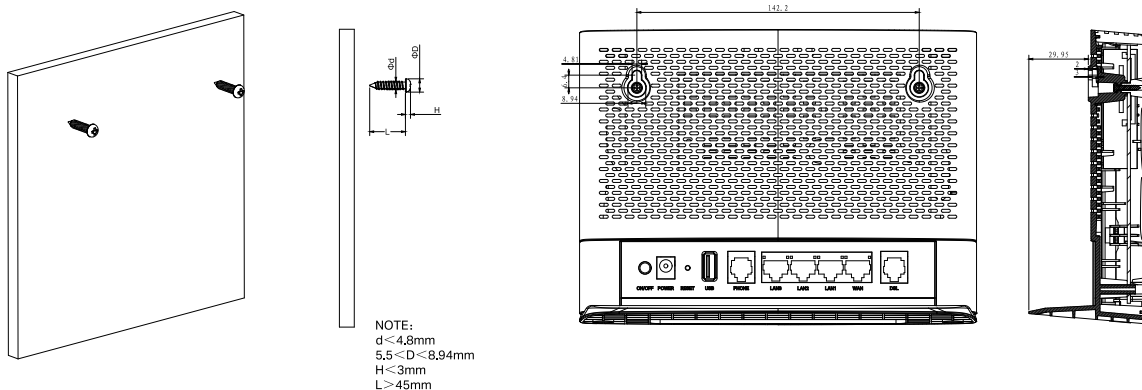

Note:

The diameter of the screw head, $5.5\text{mm} < D < 8.94\text{mm}$, and the distance of two screws is 142.2 mm. The screw that project from the wall need around 3mm based, and the length of the screw need to be at least 45mm to withstand the weight of the product.

2.2. Connect Your Modem Router

1. Follow the steps below to connect your modem router.

a. Used as a ADSL/VDSL modem router

Connect the DSL line and power adapter. The electrical outlet shall be installed near the device and shall be easily accessible.

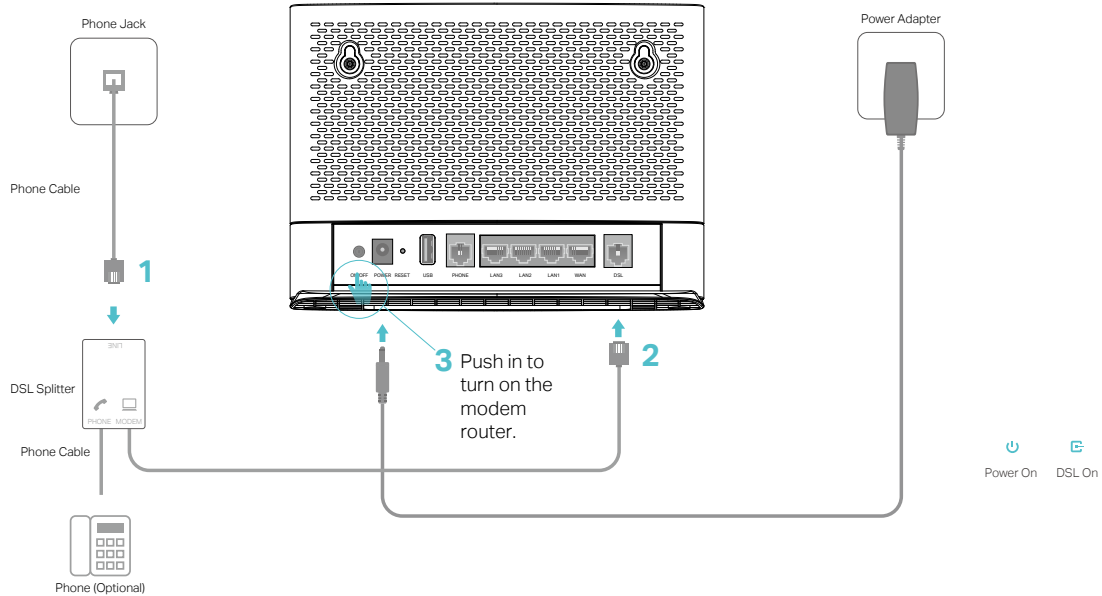

b. Used as a wireless router

If you already have a modem or your internet comes via an Ethernet jack on the wall, you can set up the modem router as a regular wireless router to share the internet.

Find the WAN port on the modem router, and connect it to your existing modem or the Ethernet jack on the wall. Then connect the power adapter and turn on the modem router. If you connect an existing modem, reboot it to get the modem router connected to the internet.

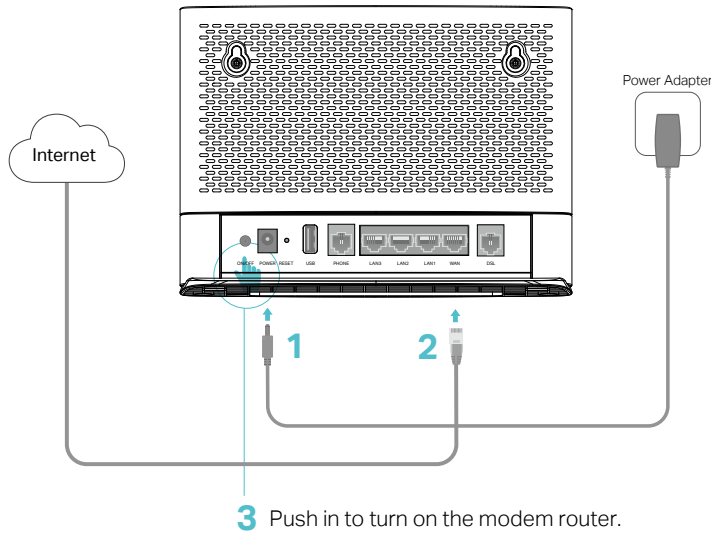

2. Connect your computer to the modem router.

Method 1: Wired

Connect your computer’s Ethernet port to the LAN port on the modem router via the Ethernet cable.

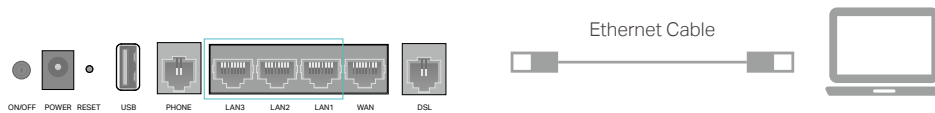

Method 2: Wirelessly

Use the default SSID (Wireless Network Name) and Wireless Password printed on the product label of the modem router to connect wirelessly.

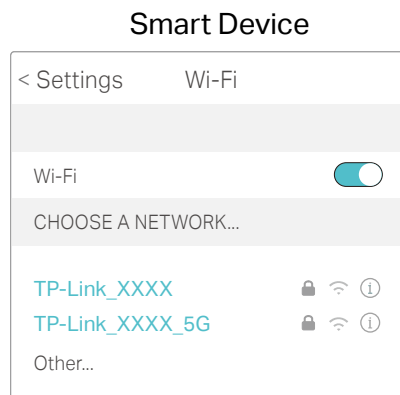
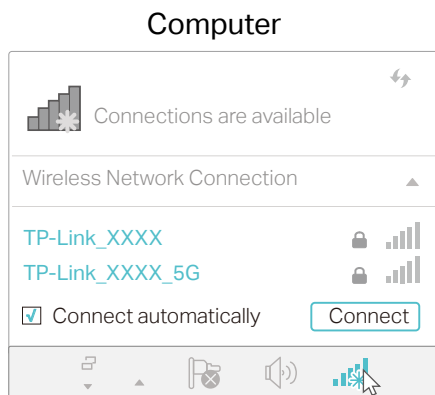

Method 3: Use the WPS button

Wireless devices that support WPS, including Android phones, tablets, most USB network cards, can be connected to your router through this method. (WPS is not supported by iOS devices.)

Note:

The WPS function cannot be configured if the wireless function of the router is disabled. Also, the WPS function will be disabled if your wireless encryption is WEP or Enterprise. Please make sure the wireless function is enabled and is configured with the appropriate encryption before configuring the WPS.

- 1) Tap the WPS icon on the device's screen.
- 2) Immediately press the WPS button on your modem router.
- 3) The WPS LED flashes for about two minutes during the WPS process.
- 4) When the WPS LED is on, the client device has successfully connected to the modem router.



Chapter 3

Log In to Your Modem Router

With a web-based utility, it is easy to configure and manage the router. The web-based utility can be used on any Windows, Mac OS or UNIX OS with a Web browser, such as Microsoft Internet Explorer, Mozilla Firefox or Apple Safari.

Follow the steps below to log in to your router.

1. Set up the TCP/IP Protocol in [Obtain an IP address automatically](#) mode on your computer.
2. Visit <http://tplinkmodem.net> or <http://192.168.1.1>, and create a login password for secure management purposes. Then click [Save](#) to log in.

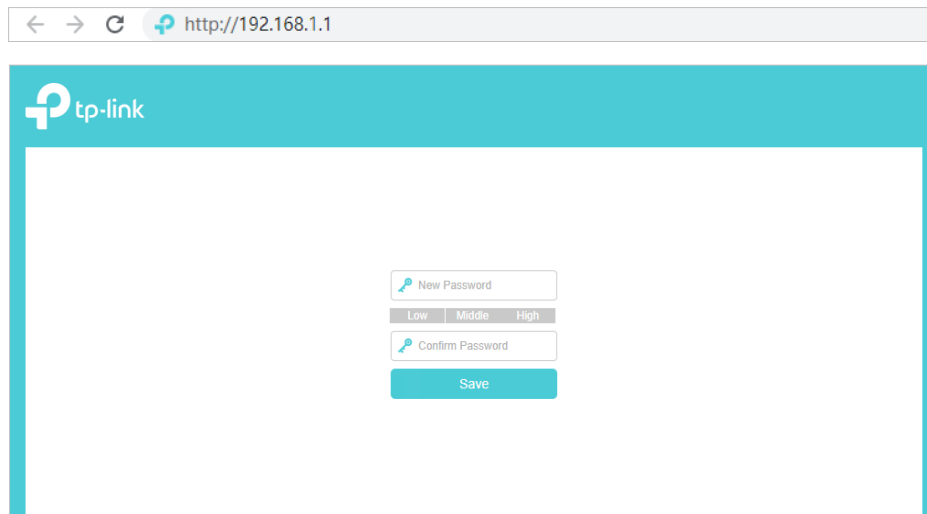

Note:

- If the login window does not appear, please refer to the [FAQ](#) Section.

Chapter 4

Set Up Internet Connection

This chapter introduces how to connect your modem router to the internet. The modem router is equipped with a web-based Quick Setup wizard. It has necessary ISP information built in, automates many of the steps and verifies that those steps have been successfully completed. Furthermore, you can also set up an IPv6 connection if your ISP provides IPv6 service.

It contains the following sections:

- [Use Quick Setup Wizard](#)
- [Quick Setup Via TP-Link Aginet App](#)
- [Manually Set Up Your Internet Connection](#)
- [Test Internet Connectivity](#)
- [Set Up an IPv6 Internet Connection](#)
- [IPv6 Tunnel](#)

4.1. Use Quick Setup Wizard

The Quick Setup Wizard will guide you to set up your router.

🔗 **Tips:**

If you need the IPv6 internet connection, please refer to the section of [Set Up an IPv6 Internet Connection](#).

Follow the steps below to set up your modem router.

1. Visit <http://tplinkmodem.net> or <http://192.168.1.1>, and log in with the password you set for the modem router.

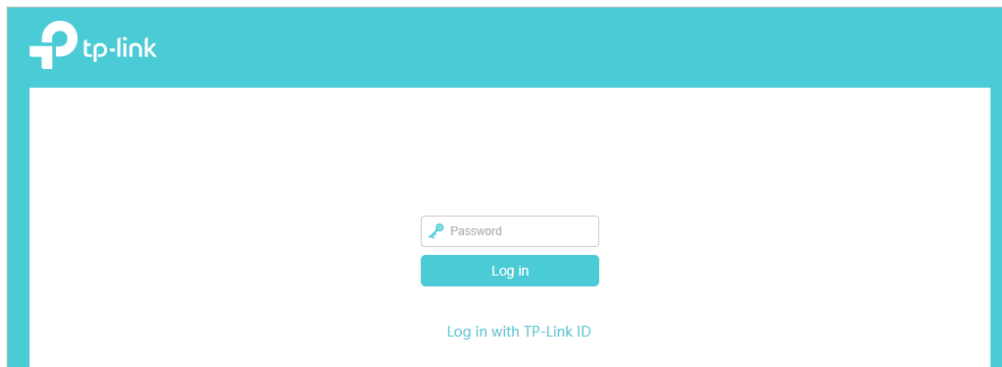

2. Follow the step-by-step instructions to complete Quick Setup configuration or go to [Quick Setup](#) for configuration to connect your router to the internet. Then follow the step-by-step instructions to connect your router to the internet.

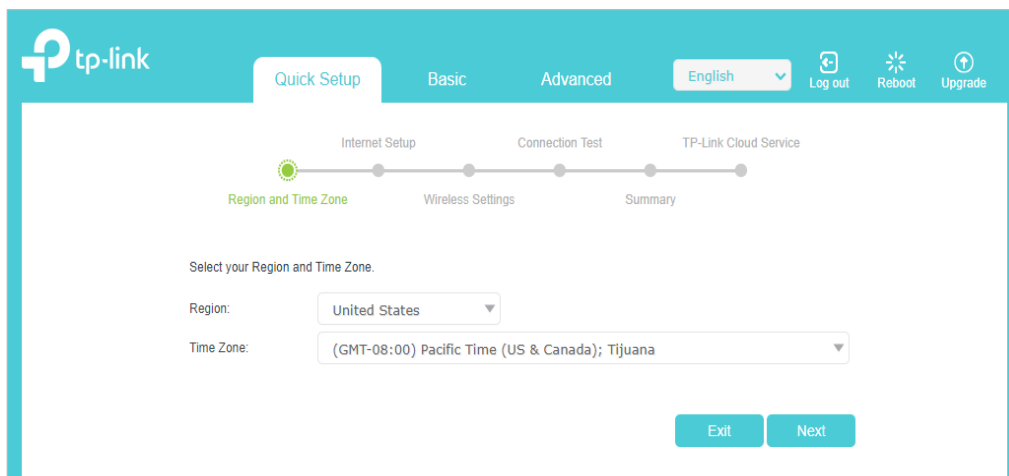

3. To enjoy a more complete service from TP-Link (remote management, TP-Link DDNS, and more.), log in with your TP-Link ID or click [Sign Up Now](#) to get one. Then follow the instructions to bind the cloud router to your TP-Link ID.

Get TP-Link Cloud Service

Log in to bind the router to your TP-Link ID. You can manage your network remotely via the Tether app, get notified of the latest firmware updates and more.

TP-Link ID (Email):

Password:

LOG IN

[Sign Up Now](#) [Forgot Password?](#)

SKIP

Note:

- To learn more about the TP-Link Cloud service, please refer to the [TP-Link Cloud Service](#) section.
- If you do not want to register a TP-Link ID now, you may click [Skip](#) to proceed.
- If you have changed the preset wireless network name (SSID) and wireless password during the Quick Setup process, all your wireless devices must use the new SSID and password to connect to the router.

4.2. Quick Setup Via TP-Link Aginet App

The Aginet app runs on iOS and Android devices, such as smartphones and tablets.

1. Launch the Apple App Store or Google Play store and search “TP-Link Aginet” or simply scan the QR code to download and install the app.



2. Launch the Aginet app and log in with your TP-Link ID.

Note: If you don't have a TP-Link ID, create one first.

3. Tap the [Create a Network](#) button and select how you will connect your device to the internet. Follow the steps to complete the setup and connect to the internet.
4. Connect your devices to the newly configured wireless networks of the router and enjoy the internet!

4.3. Manually Set Up Your Internet Connection

4.3.1. Set Up Internet Connection in DSL Modem Router Mode

1. Visit <http://tplinkmodem.net> or <http://192.168.1.1>, and log in with the password you set for the modem router.
2. Go to [Advanced](#) > [Network](#) > [DSLWAN](#) page, click [Add](#). Enter the information provided by your ISP.

The screenshot shows the 'Internet Connections' management page. At the top, there are buttons for 'Refresh', '+ Add', and '- Delete All'. Below this is a table with columns: WAN Interface Name, VPI/VCI or VID, Status, Operation, and Modify. The table is currently empty. Below the table is the 'Internet Connection Setup' form with the following fields:

- DSL Modulation Type: VDSL ADSL
- Service Type: Internet IPTV VoIP TR069 Others
- VLAN ID: Enable
- Internet Connection Type:
- Username:
- Password:
- Confirm Password:
- Connection Mode: Auto On Demand Manually
- Authentication Type:
- IPv4: Enable
- Default Gateway:
- IPv6: Enable

3. Click [OK](#) to make the settings effective, and you can refer to [Test Internet Connectivity](#) to test the Internet connection.

Tips: You can view and edit all Internet connections on [Advanced](#) > [Network](#) > [DSLWAN](#) page.

4.3.2. Set Up Internet Connection in EWAN Router Mode

1. Visit <http://tplinkmodem.net> or <http://192.168.1.1>, and log in with the password you set for the modem router.
2. Go to [Advanced](#) > [Network](#) > [EWAN](#) page, enable EWAN Connection.

3. Confirm the information provided by your ISP and click **OK** to connect to the internet.

Internet Setup

Refresh + Add - Delete All

Connection Name	Service Type	VLAN ID	Status	Operation	Enable	Modify
--	--	--	--	--	--	--

Connection Name: (Optional)

Enable This Entry

Service Type: Internet IPTV VoIP TR069 Others

Default Gateway:

Internet Connection Type:

VLAN ID: Enable

Username:

Password:

Confirm Password:

Connection Mode: Auto On Demand Manually

Authentication Type:

IPv4: Enable

IPv6: Enable

4.4. Test Internet Connectivity

After manually setting up the Internet connection, you need to test the Internet connectivity. The modem router provides a diagnostic tool to help you locate the malfunction.

1. Visit <http://tplinkmodem.net> or <http://192.168.1.1>, and log in with the password you set for the modem router.
2. Go to **Advanced > System Tools > Diagnostics** page.

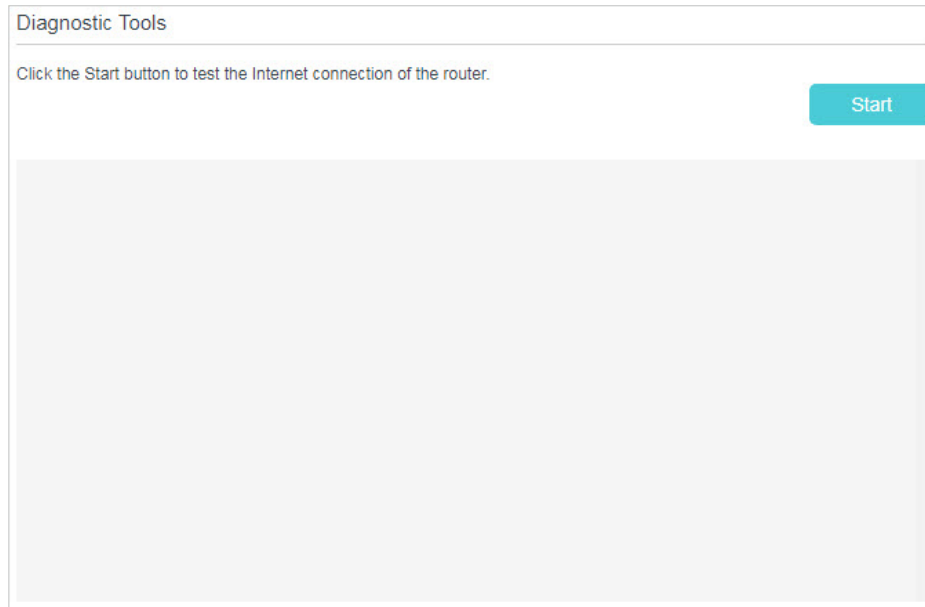

3. Click [Start](#) to test the Internet connectivity and you will see the test result in the gray box.

4. 5. Set Up an IPv6 Internet Connection

4. 5. 1. Set Up Internet Connection in DSL Modem Router Mode

If your ISP has provided a DSL line that supports IPv6 connection as well as some detailed IPv6 parameters, you can manually set up an IPv6 connection.

If your ISP provides an IPv4-only connection or IPv6 tunnel service, permit IPv6 connection by referring to [IPv6 Tunnel](#).

Follow the steps below to set up an IPv6 connection:

1. Make sure you have set up an IPv4 connection before setting up an IPv6 connection.
2. Visit <http://tplinkmodem.net> or <http://192.168.1.1>, and log in with the password you set for the modem router.
3. Go to [Advanced](#) > [Network](#) > [DSLWAN](#) page.

Internet Connections				
WAN Interface Name	VPI/VCI or VID	Status	Operation	Modify
pppoe_8_35_1_d	8/35	DSL Connected	Disconnect	

4. Select your WAN Interface Name (Status should be **DSL Connected**) and click the  (Edit) icon.
5. Scroll down the page, enable **IPv6**, and configure the IPv6 parameters.

IPv6:	<input checked="" type="checkbox"/> Enable
IPv6 Address:	::
Prefix Length:	64
IPv6 Gateway:	::
Addressing Type:	SLAAC ▼
IPv6 Default Gateway:	Current Connection ▼

- **Addressing Type:** Consult your ISP for the addressing type, **DHCPv6** or **SLAAC** or **Auto**. SLAAC is the most commonly used addressing type.

Note: If your ISP has provided the IPv6 address, click **Advanced** to reveal more settings. Check to use IPv6 specified by ISP and enter the parameters provided by your ISP.

6. Click **OK** to make the settings effective. Now IPv6 service is available for your network.

4.5.2. Set Up Internet Connection in EWAN Router Mode

In Wireless Router Mode, you can also permit IPv6 connection by setting up an IPv6 connection or the IPv6 tunnel just as in the DSL Modem Router Mode.

1. Make sure you have set up an IPv4 connection before setting up an IPv6 connection.
2. Visit <http://tplinkmodem.net> or <http://192.168.1.1>, and log in with the password you set for the modem router.
3. Go to **Advanced** > **Network** > **EWAN** page.
4. Scroll down the page, enable **IPv6**, and configure the IPv6 parameters.
5. Click **OK** to make the settings effective. Now IPv6 service is available for your network.

IPv6:	<input checked="" type="checkbox"/> Enable
IPv6 Address:	::
Prefix Length:	0
IPv6 Gateway:	::
Addressing Type:	SLAAC ▼

4.6. IPv6 Tunnel

IPv6 Tunnel is a transition mechanism that enables IPv6-only hosts to reach IPv4 services or vice versa and allows isolated IPv6 hosts and networks to reach each other over IPv4-only infrastructure before IPv6 completely supplants IPv4. It is a temporary solution for networks that do not support native dual-stack, where both IPv6 and IPv4 run independently.

1. Visit <http://tplinkmodem.net> or <http://192.168.1.1>, and log in with the password you set for the modem router.
2. Go to [Advanced](#) > [Network](#) > [EWAN](#).
3. Click [Add](#) and enable IPv6 and Click [Advanced](#) to view more advanced settings.
4. Select the checkbox to enable IPv6 Tunnel.

IPv6: Enable

IPv6 Address: ::

Prefix Length: 0

IPv6 Gateway: ::

Addressing Type:

Advanced

IPv6 Tunnel: Enable

Mechanism:

Configuration Type: Auto Manual

MTU Size: (bytes.(The default is 1500, do not change unless necessary.))

MLD Proxy: Enable

Use the Following IPv6 DNS Address: Enable

Host:

Tips:

Please check the IPv6 tunnel settings each time while reconfiguring WAN connection, as WAN connection configuration may take effect on tunnel settings.

5. Fill in information as required by different tunneling mechanisms.

- 1) **DS-Lite:** Fill in blanks and click **OK**. Select this tunneling mechanism if your ISP uses DS-Lite deployment for assigning address.

Advanced

IPv6 Tunnel: Enable

Mechanism: DS-Lite

Configuration Type: Auto Manual

MTU Size: (bytes. (The default is 1500, do not change unless necessary.))

NAT: Enable

Full-cone NAT: Enable

IGMP Proxy: Enable

Get IP Using Unicast DHCP: Enable (It is usually not required.)

Use the Following DNS Addresses: Enable

MLD Proxy: Enable

Use the Following IPv6 DNS Address: Enable

Host:

- 2) **6rd**: Fill in blanks and click **OK**. Select this tunneling mechanism if your ISP uses 6rd deployment for assigning address.

Advanced

IPv6 Tunnel: Enable

Mechanism: 6RD

Configuration Type: Auto Manual

IPv4 Mask Length:

6RD Prefix:

6RD Prefix Length:

Border Relay IPv4 Address:

MTU Size: (bytes. (The default is 1500, do not change unless necessary.))

NAT: Enable

Full-cone NAT: Enable

IGMP Proxy: Enable

Get IP Using Unicast DHCP: Enable (It is usually not required.)

Use the Following DNS Addresses: Enable

MLD Proxy: Enable

Use the Following IPv6 DNS Address: Enable

Host:

- 3) **6to4**: Fill in blanks and click **OK**. Select this tunneling mechanism if your ISP uses 6to4 deployment for assigning address.

⬆️ Advanced

IPv6 Tunnel: Enable

Mechanism: 6to4 ▼

MTU Size: (bytes. (The default is 1500, do not change unless necessary.))

NAT: Enable

Full-cone NAT: Enable

IGMP Proxy: Enable

Get IP Using Unicast DHCP: Enable (It is usually not required.)

Use the Following DNS Addresses: Enable

MLD Proxy: Enable

Use the Following IPv6 DNS Address: Enable

Host:

Chapter 5

VoIP

This chapter guides you on how to make telephone calls via Internet. You may not be able to configure VoIP when using certain models, please contact your ISP for support.

- [Connecting the Telephone](#)
- [Entering Telephone Information](#)
- [Telephone Book](#)
- [Telephony Devices Management](#)
- [Call Log](#)
- [Call Rules](#)
- [Call Blocks](#)
- [Call Forwarding](#)
- [Voice Mail Settings](#)

5.1. Connecting the Telephone

Connect your telephone to the TAE ports on the side panel or RJ11 ports on the rearpanel. Please note that you can only connect to two ports (one to a Phone 1 and the other to a Phone 2) at most.

5.2. Entering Telephone Information

Before using telephony services, you should first enter your telephone information provided by your telephony service provider.

Follow the steps below to enter information:

1. Visit <http://tplinkmodem.net> or <http://192.168.1.1>, and log in with the password you set for the modem router.
2. Go to [Advanced](#) > [Telephony](#) > [Telephone Number](#) to open the configuration page. Click [Add](#) and you will see the following screen.

Status	Telephone Number	Provider	Modify
--	--	--	--

Refresh + Add - Delete All

Telephony Provider: Other provider

Phone Number:

Registrar Address:

Authentication ID:

Password:

Advanced

Cancel OK

×	1001	Other provider	✎ 🗑
---	------	----------------	-----

3. Enter the necessary information as required, and click [OK](#) to make the settings effective.

Phone Number: The number you use to dial and answer.

Registrar Address: Usually a domain name, if not, an IP address.

Authentication ID and Password: Not necessary information, but if you have, fill them in.

Advanced: Click to have more configuration.

To have more configuration on telephony settings

Click [Advanced](#) under [Advanced Settings](#) to configure more telephony settings.

Advanced Settings

⬅ Advanced

Bound Interface:

Locale Selection:

DSCP for SIP:

DSCP for RTP:

PCP for SIP/RTP: (0-7)

DTMF Relay Setting:

Registry Expiration Time: (300-3600 seconds)

Registry Retry Interval: (30-300 seconds)

No Answer Time: (5-60 seconds)

T.38 Support: Enable

End with #: Enable

Bound Interface: Bound Interface decides where to send/receive the VoIP traffic. An easy way to select the interface is to check the location of the SIP (Session Initiation Protocol) server. If it locates somewhere on the Internet then select **Any_WAN**. If it is on the local network, select **LAN**.

Locale Selection: Select a country where you are located. The modem router is embedded with some default parameters according to different countries such as ring tones. Usually you can keep the default value.

DSCP for SIP/RTP: DSCP (Differentiated Services Code Point) is the first 6 bits in the ToS byte. DSCP marking allows users to assign specific application traffic to be executed in priority by the next Router based on the DSCP value. Select DSCP for the SIP (Session Initiation Protocol) and RTP (Real-time Transport Protocol) respectively. If you are unsure, please always keep the default value.

DTMF Relay Setting: DTMF is Dual Tone Multi Frequency. Options available are SIP-Info, RFC2833, and In-band. If you are unsure which one to choose, please always keep the default value.

- **SIP INFO:** If it is selected, the modem router will capture the DTMF tone and transfer it into SIP form. Then it will be sent to the remote end with SIP message.
- **RFC2833:** If it is selected, the modem router will capture the keypad number you pressed and transfer it into digital form then send to the other side; the receiver will generate the tone according to the digital form it receives. This function is very useful when the network traffic congestion occurs and it still can remain the accuracy of DTMF tone.

- **In-band:** If it is selected, the modem router will send the DTMF tone as audio directly when you press the keypad on the phone.

Registry Expiration Time: Expiration time for the registration message sending.

Registration Retry Interval: Set the time duration for your SIP Registrar server to keep your registration record. Before the time expires, the Modem Router will send another register request to SIP Registrar again. If you are unsure of it, please always keep the default value.

No answer Time: Set a time period, after which the caller is told that the call is not answered and he or she can leave a message if the voice mail function is enabled.

T.38 support: Select the checkbox to enable this function. T 38 specifies a protocol for transmitting a fax across IP network in real time. It allows the transfer of fax documents in real-time between two standard Group 3 facsimile terminals over the Internet or other networks using IP protocols. It will only function when both sites support this feature and are enabled.

End with: Select the checkbox to use the pound sign (#) as an end-of-dialing.

When the **Status** column change to , your telephone information is successfully registered. At this time, you can pick up your phone, dial the number, and call via Internet!

5.3. Telephone Book

You can store all contacts on your modem router, have a telephone book, set speed dial number for some contacts and enable emergency calls.

5.3.1. Telephone Book

Follow the steps below to have a telephone book on the modem router.

1. Visit <http://tplinkmodem.net> or <http://192.168.1.1>, and log in with the password you set for the modem router.
2. Go to **Advanced > Telephony > Telephone Book**. Click **Add** to enter a new contact's information.

Telephone Book

+ Add - Delete All

Name	Telephone Number	Speed Dial Number	Modify
--	--	--	--

First Name:

Last Name:

Private Phone Number:

Work Phone Number:

Mobile Phone Number:

Speed Dial Number Type:

Speed Dial Number:

3. You can set speed dial number for certain numbers. Speed dial function allows you to reach the desired party by dialing the reduced number of keys rather than a long phone number.
4. Click [Save](#) to save the settings.

5.3.2. Emergency Calls

I want to: Make my telephone automatically call a specific contact when the handset is picked up but no operation is done within a period of time. In this way the old, the kids, the patient or the pregnant in house are able to send signals for help when emergencies occur.

How can I do that?

1. Visit <http://tplinkmodem.net> or <http://192.168.1.1>, and log in with the password you set for the modem router.
2. Go to [Advanced](#) > [Telephony](#) > [Telephone Book](#).

Emergency Number Settings

Emergency Number:

No Operation Time: 3s ▼

Emergency Number1:

Emergency Number2:

Emergency Number3:

Emergency Number4:

Emergency Number5:

Save

3. Enable Emergency Number.
4. **No Operation Time:** Set how long should the telephone wait before the first number is automatically dialed).
5. **Emergency Number:** Set the number to be automatically reached. If more than one number is set, the modem router will automatically call the next one if the previous is not answered.
6. Click **Save** to make the settings effective.

Done!

From now on, if you pick up your phone but do not dial within the no operation time, your phone will automatically call the emergency number!

5.4. Telephony Devices Management

I want to:

Bind different telephony devices with different incoming and outgoing call numbers, because I have more than one telephone number and telephony device and I don't want all telephones ring at the same time when a number is called.

How can I do that?

1. Visit <http://tplinkmodem.net> or <http://192.168.1.1>, and log in with the password you set for the modem router.
2. Go to **Advanced > Telephony > Telephony Devices**.

Telephony Devices			
Device Name	Number for Incoming Calls	Number for Outgoing Calls	Modify
Phone 1	1001	Auto	

3. Click  to manage your telephony devices.

Telephony Devices			
Device Name	Number for Incoming Calls	Number for Outgoing Calls	Modify
Phone 1	1001	Auto	

Device name:

Number for Outgoing Calls:

Number for Incoming Calls: 1001

VAD Support: Enable VAD

Speaker Gain:

Mic Gain:

4. **Device Name:** Name the telephone device here.
5. **Number for Outgoing Calls:** Assign an outgoing number for this phone.
6. **Number for Incoming Calls:** Tick the incoming number for this phone.
7. **VAD Support:** VAD (Voice Activation Detection) prevents transmitting the silence packets to consume the bandwidth. It is also known as Silence Suppression, a software application that ensures bandwidth when voice activity is activated.
8. Adjust the **Speaker Gain** slider to control the speaker sound.
9. Adjust the **Mic Gain** slider to control the speaker sound of microphone.
10. Click **Save** to make the settings effective.

Done!

Now your telephony devices are bound to different incoming call numbers and outgoing call numbers.

 Tips:

Internal number showed on the table are used to make calls between telephony devices connected to the same modem router. It is preset and cannot be changed.

5.5. Call Log

I want to: Have a call list recording detailed information of incoming calls and outgoing calls on your modem router.

How can I do that?

1. Visit <http://tplinkmodem.net> or <http://192.168.1.1>, and log in with the password you set for the modem router.
2. Go to [Advanced](#) > [Telephony](#) > [Call Log](#).

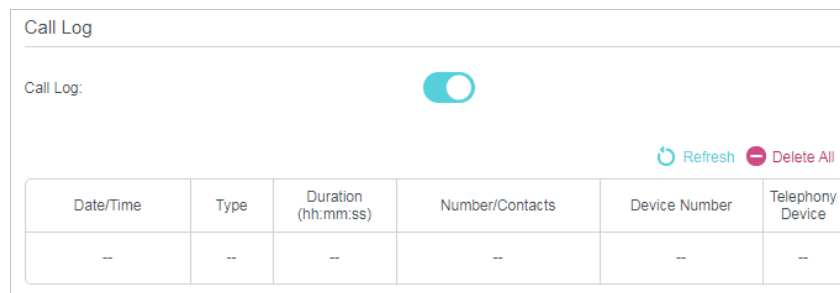

3. Enable Call Log.

Done!

From now on, all calls in and out are recorded here. If you've already had a telephone book, name of the contact would be shown on the call list.

5.6. Call Rules

Call Rules allows you to call different types of numbers using different outgoing numbers if you have more than one telephone account.

1. Visit <http://tplinkmodem.net> or <http://192.168.1.1>, and log in with the password you set for the modem router.
2. Go to [Advanced](#) > [Telephony](#) > [Call Rules](#). Click [Add](#) to enter a new contact's information.

3. Select a **Call Type** from the drop-down list, including Mobile, Landline, Long Distance, or International. If Calls with Specific Number Prefix is selected, add the Number Prefix.
4. Select a **Number for Outgoing Calls** from the drop-down list. If the dialing number matches the defined call type or number prefix, the dialing number will be routed to the specified network according to the rule.
5. Click **OK**.

5.7. Call Blocks

When you do not want calls to be received or dialed, use call block functions. This part consists of three functions: Do Not Disturb, Block Certain Calls and Prevent from Dialing.

5.7.1. Do Not Disturb

I want to: Have no telephone ring at a certain period of time.

How can I do that?

1. Visit <http://tplinkmodem.net> or <http://192.168.1.1>, and log in with the password you set for the modem router.
2. Go to **Advanced > Telephony > DND & Call Blocking**.

3. Enable [DND](#).
4. Set the day(s) when DND is enabled.
5. Click [Save](#) to make the settings effective.

Done!

Now, within this period of time, no telephone will ring, but all incoming calls would be recorded in call log. Enjoy your peaceful time and when you are back, check the call log to see what was missed.

5.7.2. Blocking Certain Calls

I want to:

Block certain calls, for example, the anonymous calls, or calls from the annoying salesmen.

How can I do that?

1. Visit <http://tplinkmodem.net> or <http://192.168.1.1>, and log in with the password you set for the modem router.
2. Go to [Advanced](#) > [Telephony](#) > [DND & Call Blocking](#).

Call Blocking	
Incoming Calls	
+ Add - Delete All	
Number	Modify
--	--

3. Click [Add](#) under [Incoming Calls](#).
4. Choose to block a specific number or anonymous calls.
5. Click [OK](#) to make the settings effective.

Done!

Now your modem router will automatically callout matching to your dial plan.

5.7.3. Prevent from Dialing

I want to:

Prevent my modem router from dialing a certain type of numbers. [For example](#), it costs a lot to call a mobile phone via my telephone number, so I don't want anyone to call a mobile phone using my number.

How can I do that?

1. Visit <http://tplinkmodem.net> or <http://192.168.1.1>, and log in with the password you set for the modem router.
2. Go to [Advanced](#) > [Telephony](#) > [DND & Call Blocking](#).

Call Type or Prefix	Modify
--	--

3. Click [Add](#) under [Outgoing Calls](#).
4. Choose to prevent mobile phone from being dialed. Number type may vary according to your circumstances.
5. Click [OK](#) to make the settings effective.

Done!

Now your modem router will prevent all mobile phone from being dialed.

In addition:

Number type may vary according to your circumstances. You can also set prefix by choosing [Calls with Specific Number Prefix](#). When a prefix is set, all numbers with this prefix is prevented from being called.

5. 8. Call Forwarding

Call Forwarding allows you to redirect incoming calls to a designated phone number.

1. Visit <http://tplinkmodem.net> or <http://192.168.1.1>, and log in with the password you set for the modem router.
2. Go to [Advanced](#) > [Telephony](#) > [Call Forwarding](#). Click [Add](#) to enter a new contact's information.
3. Select a call type to be forwarded.

Call Forwarding + Add - Delete All

Calls	Forward via	Destination Number	Forward Type	Enable	Modify
--	--	--	--	--	--

Select the incoming calls to be forwarded.

All Incoming Calls

Calls to the Telephone Number -Please Select- ▼

Calls to the Phone -Please Select- ▼

Calls from a Person in the Telephone Book -Please Select- ▼

Calls from the Telephone Number []

Set Forwarding Rules:

Destination Telephone Number: []

Call Forward Condition: Unconditional ▼

Cancel
OK

All Incoming Calls: If this option is selected, all incoming calls will be forwarded.

Calls to the Telephone Number: If this option is selected, select a telephone number from the list. Any incoming calls to this number will be forwarded.

Calls to the Phone: If this option is selected, select a telephony device from the list. Any incoming calls to this device will be forwarded.

Calls from a Person in the Telephone Book: If this option is selected, select a contact from the list. Any incoming calls from this contact will be forwarded.

Calls from the Telephone Number: If this option is selected, enter a specific telephone number. Any incoming calls from this number will be forwarded.

4. Enter a Destination Telephone Number that incoming calls will be redirected to.
5. Select Forward the Calls via from the drop-down list.
6. Select the Call Forward Condition:

Unconditional: All incoming calls will be redirected to the designated telephone number whether the receiver is busy or not.

No Answer: Incoming calls that are not answered for the specified time period will be redirected to the designated telephone number.

7. Click **OK**.

Note: If you want to disable this entry, click the Bulb icon.

5.9. Voice Mail Settings

Voice Mail allows callers to leave voice messages on an external USB storage device with the appropriate configuration files when calls are not answered. To use this function, plug the USB storage device into the USB port on the router.

1. Visit <http://tplinkmodem.net> or <http://192.168.1.1>, and log in with the password you set for the modem router.
2. Go to **Advanced > Telephony > Voice Mail**. Toggle On to enable Voice Mail.

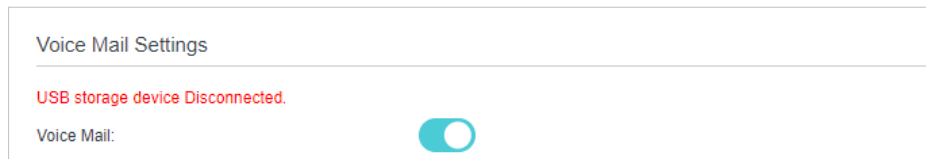

Voice Mail Settings

USB storage device Disconnected.

Voice Mail:

3. Select the **Greeting for Voice Mail** to use either the default or your custom greeting for the voice mail. You can click the Play icon to play the greeting.

Note: Pick up the phone (analog phone or DECT handset) and dial *30 to record a personalized greeting for your voice mail.

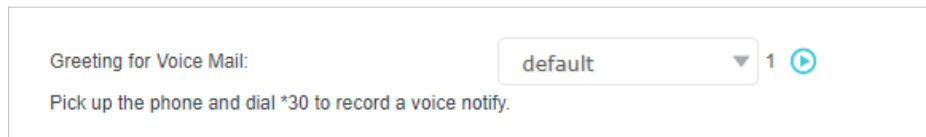

Greeting for Voice Mail: default

Pick up the phone and dial *30 to record a voice notify.

4. Enter a value in seconds in the **Voice Mail Duration** field to limit the length of each voice mail.

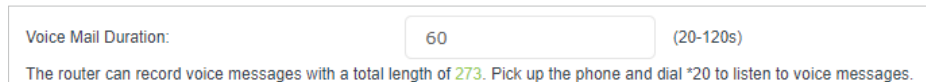

Voice Mail Duration: 60 (20-120s)

The router can record voice messages with a total length of 273. Pick up the phone and dial *20 to listen to voice messages.

5. (Optional) If you want to listen to your voice mails remotely, toggle On to enable **Remote Access to Voice Mail** and create a PIN in the **Remote Access PIN** field.

Note: To access your voice mail remotely, dial the number for incoming calls. When your personal greeting starts, press *. Enter your Remote Access PIN when prompted.

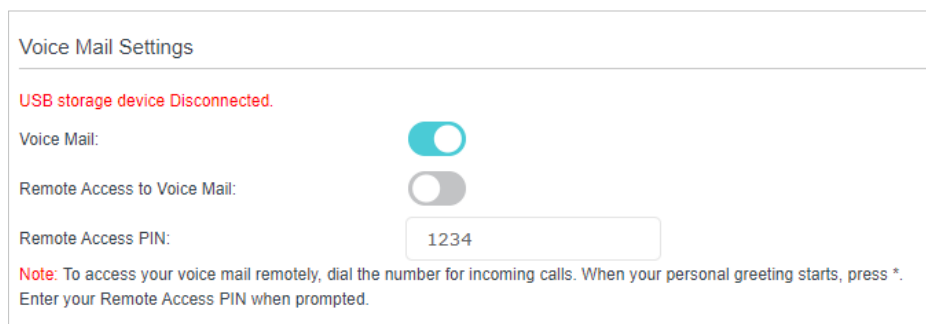

Voice Mail Settings

USB storage device Disconnected.

Voice Mail:

Remote Access to Voice Mail:

Remote Access PIN: 1234

Note: To access your voice mail remotely, dial the number for incoming calls. When your personal greeting starts, press *. Enter your Remote Access PIN when prompted.

Chapter 6

Customize Your Network Settings

This chapter introduces how to change the default settings or adjust the basic configuration of the modem router using the web management page.

It contains the following sections:

- [Configure LAN Settings](#)
- [Configure IPv6 LAN Settings](#)
- [Set Up a Dynamic DNS Service Account](#)
- [Create Static Routes](#)
- [RIP Settings](#)
- [Specify Wireless Settings](#)
- [Schedule Your Wireless Function](#)
- [Use WPS for Wireless Connection](#)

6.1. Configure LAN Settings

6.1.1. Change the LAN IP Address

The modem router is preset with a default LAN IP 192.168.1.1, which you can use to log in to its web management page. The LAN IP address together with the Subnet Mask also defines the subnet that the connected devices are on. If the IP address conflicts with another device in your local network or your network requires a specific IP subnet, you can change it.

Follow the steps below to change your IP address.

1. Visit <http://tplinkmodem.net> or <http://192.168.1.1>, and log in with the password you set for the modem router.
2. Go to [Advanced](#) > [Network](#) > [LAN Settings](#) page and select [IPv4](#).

DHCP Server		IPv4	IPv6
MAC Address:	00:0A:EB:13:09:69		
IP Address:	192.168.1.1		
Subnet Mask:	255.255.255.0		
IGMP Snooping:	<input checked="" type="checkbox"/> Enable		
Second IP:	<input type="checkbox"/> Enable		

3. Enter a new [IP Address](#) appropriate to your needs.
4. Select the [Subnet Mask](#) from the drop-down list. The subnet mask together with the IP address identifies the local IP subnet.
5. Keep [IGMP Snooping](#) enabled by default. IGMP snooping is the process of listening to IGMP (Internet Group Management Protocol) network traffic. The function prevents hosts on a local network from receiving traffic for a multicast group they have not explicitly joined.
6. You can configure the router's [Second IP](#) and [Subnet Mask](#) for LAN interface through which you can also access the web management page.
7. Keep the rest settings as the default settings.
8. Click [Save](#) to make the settings effective.

6.1.2. Use the Router as a DHCP Server

You can configure the router to act as a DHCP server to assign IP addresses to its clients. To use the DHCP server function of the router, you must configure all computers on the LAN to obtain an IP Address automatically.

Follow the steps below to configure DHCP server.

1. Visit <http://tplinkmodem.net> or <http://192.168.1.1>, and log in with the password you set for the modem router.
2. Go to [Advanced](#) > [Network](#) > [LAN Settings](#) page and select [IPv4](#).

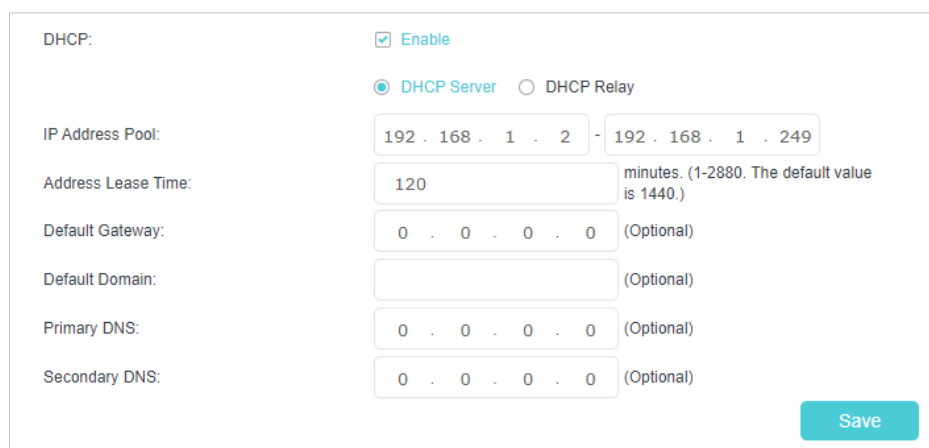

DHCP: Enable

DHCP Server DHCP Relay

IP Address Pool: 192 . 168 . 1 . 2 - 192 . 168 . 1 . 249

Address Lease Time: 120 minutes. (1-2880. The default value is 1440.)

Default Gateway: 0 . 0 . 0 . 0 (Optional)

Default Domain: (Optional)

Primary DNS: 0 . 0 . 0 . 0 (Optional)

Secondary DNS: 0 . 0 . 0 . 0 (Optional)

Save

3. Enable [DHCP](#) function and select [DHCP Server](#).
4. Specify the [IP Address Pool](#), the start address and end address must be on the same subnet with LAN IP. The router will assign addresses within this specified range to its clients. It is from 192.168.1.100 to 192.168.1.249 by default.
5. Enter a time duration in the [Address Lease Time](#) field. The [Address Lease Time](#) is the amount of time in which a DHCP client can lease its current dynamic IP address assigned by the router. After the dynamic IP address expires, the user will be automatically assigned a new dynamic IP address.
6. Keep the rest settings as the default settings and click [Save](#).

Note:

1. The router can be configured to work as a [DHCP Relay](#). A DHCP relay is a computer that forwards DHCP data between computers that request IP addresses and the DHCP server that assigns the addresses. Each of the device's interfaces can be configured as a DHCP relay. If it is enabled, the DHCP requests from local PCs will be forwarded to the DHCP server that runs on WAN side.
2. You can also appoint IP addresses within a specified range to devices of the same type by using [Condition Pool](#) feature. For example, you can assign IP addresses within the range (192.168.0.50 to 192.168.0.80) to Camera devices, thus facilitating the network management. Enable DHCP feature and configure the parameters according to your situation on the [Advanced](#) > [Network](#) > [LAN Settings](#) page.

6.1.3. Client List

Client list displays the information of currently connected devices.

1. Visit <http://tplinkmodem.net> or <http://192.168.1.1>, and log in with the password you set for the modem router.
2. Go to [Advanced](#) > [Network](#) > [LAN Settings](#) > [Client List](#) page.



Client List				
Total Clients: 0				 Refresh
ID	Client Name	MAC Address	Assigned IP	Leased Time
--	--	--	--	--

6.1.4. Reserve LAN IP Addresses

You can view and add a reserved address for a client. When you specify an IP address for a device on the LAN, that device will always receive the same IP address each time when it accesses the DHCP server. If there are some devices in the LAN that require permanent IP addresses, please configure Address Reservation on the router for the purpose.

Follow the steps below to reserve an IP address for your devices.

1. Visit <http://tplinkmodem.net> or <http://192.168.1.1>, and log in with the password you set for the modem router.
2. Go to [Advanced](#) > [Network](#) > [LAN Settings](#) page, and select [IPv4](#).
3. Scroll down to the [Address Reservation](#) section, and click [Add](#) to add an address reservation entry for your device.

Address Reservation					
					 Add  Delete
<input type="checkbox"/>	MAC Address	Reserved IP Address	Group	Enable	Modify
--	--	--	--	--	--

MAC Address:	<input type="text" value="- - - - -"/>	<input type="button" value="Scan"/>
IP Address:	<input type="text" value=". . ."/>	
Group:	<input type="text" value="Default"/>	
	<input checked="" type="checkbox"/> Enable This Entry	
		<input type="button" value="Cancel"/> <input type="button" value="OK"/>

4. Enter the **MAC Address** of the device for which you want to reserve IP address.
5. Specify the **IP address** which will be reserved by the router.
6. Select the **Enable This Entry** check box and click **OK** to make the settings effective.

6.1.5. Condition Pool

Condition Pool is used to configure IP address pools for certain devices or is used under the guidance of your device provider. The table displays the corresponding parameters of all the condition pools.

Follow the steps below to add a condition pool.

1. Visit <http://tplinkmodem.net> or <http://192.168.1.1>, and log in with the password you set for the modem router.
2. Go to **Advanced > Network > LAN Settings** page, and select **IPv4**.
3. Click **Add**.

Condition Pool

+ Add - Delete

<input type="checkbox"/>	Vendor ID	Starting IP Address/Ending IP Address	Facility	Group	Status	Modify
--	--	--	--	--	--	--

Device Name:

Vendor ID:

Starting IP Address:

Ending IP Address:

Default Gateway:

Device Type:

Add Option:

Option Value:

Group:

Enable This Entry

Cancel
OK

4. Give a description to the condition pool in the **Device Name** field.
5. Enter a value to identify the **Vendor ID** and functionality of the DHCP client.
6. Enter the **Starting/Ending IP Address** to decide the IP address range the DHCP server can assign to clients.

7. Enter the [Default Gateway](#) of the DHCP server.
8. Select a [Device Type](#) from the drop-down list to decide which kind of device will obtain IP address from this pool.
9. Select an option from the drop-down list and enter the option value.
10. Select a [Group](#) from the drop-down list.
11. Select [Enable This Entry](#).
12. Click [OK](#).

■ **Note:** If you want to disable this entry, click the Bulb icon.

6.2. Configure IPv6 LAN Settings

Based on the IPv6 protocol, the router provides two ways to assign IPv6 LAN addresses:

- Configure the RADVD (Router Advertisement Daemon) address type
- Configure the DHCPv6 Server address type

6.2.1. Configure the RADVD Address Type

1. Visit <http://tplinkmodem.net> or <http://192.168.1.1>, and log in with the password you set for the modem router.
2. Go to [Advanced](#) > [Network](#) > [LAN Settings](#).
3. Select [IPv6](#) to configure IPv6 LAN parameters.

The screenshot shows the 'DHCP Server' configuration page for IPv6. The 'Group' is set to 'Default'. The 'Address Type' is set to 'RADVD'. The 'Enable RDNSS' and 'Enable ULA Prefix' options are unchecked. The 'Site Prefix Type' is set to 'Delegated'. The 'WAN Connection' is set to 'No available interface'. A 'Save' button is visible at the bottom right.

- 1) Select [RADVD](#) as the address type to make the router assign IPv6 address prefixes to hosts.

■ **Note:**

Do not select the [Enable RDNSS](#) and [Enable ULA Prefix](#) check boxes unless required by your ISP. Otherwise you may not be able to access the IPv6 network. For more information about RDNSS and ULA Prefix, contact our technical support.

- 2) Keep [Site Prefix Type](#) as the default setting [Delegated](#). If your ISP has provided a specific IPv6 site prefix, select [Static](#) and enter the prefix.
 - 3) Keep [WAN Connection](#) as the default settings.
4. Click [Save](#) to make the settings effective.

6.2.2. Configure the DHCPv6 Server Address Type

1. Visit <http://tplinkmodem.net> or <http://192.168.1.1>, and log in with the password you set for the modem router.
2. Go to [Advanced](#) > [Network](#) > [LAN Settings](#).
3. Select [IPv6](#) to configure IPv6 LAN parameters.

The screenshot shows the 'DHCP Server' configuration page for IPv6. The page has a title bar with 'DHCP Server' on the left and 'IPv4 | IPv6' on the right. The main content area contains several settings:

- Group:** Default
- Address Type:** Two radio buttons are present: 'RADVD' (unselected) and 'DHCPv6 Server' (selected).
- Starting IPv6 Address:** A text input field contains '1', with '(1~FFFE)' to its right.
- Ending IPv6 Address:** A text input field contains 'FFFE', with '(1~FFFE)' to its right.
- Address Lease Time:** A text input field contains '7200', with 'seconds' to its right.
- Site Prefix Type:** Two radio buttons are present: 'Delegated' (selected) and 'Static' (unselected).
- WAN Connection:** A dropdown menu shows 'No available interface'.

A blue 'Save' button is located in the bottom right corner of the form.

- 1) Select [DHCPv6 Server](#) as the address type to make the router assign IPv6 addresses to hosts.
 - 2) Specify the [Starting/Ending IPv6 Address](#) for the IPv6 suffixes. The router will generate IPv6 addresses within the specified range.
 - 3) Keep [Address Lease Time](#) as the default setting.
 - 4) Keep [Site Prefix Type](#) as the default value [Delegated](#). If your ISP has provided a specific IPv6 site prefix, select [Static](#) and enter the prefix.
 - 5) Keep [WAN Connection](#) as the default setting.
4. Click [Save](#) to make the settings effective.

6.3. Configure DSL Settings

Follow the steps below to change your IP address.

1. Visit <http://tplinkmodem.net> or <http://192.168.1.1>, and log in with the password you set for the modem router.
2. Go to [Advanced](#) > [Network](#) > [DSL Settings](#) page.
3. Select a [DSL Modulation Type/Annex Type](#) from the drop-down list. Do not change the default settings unless necessary.

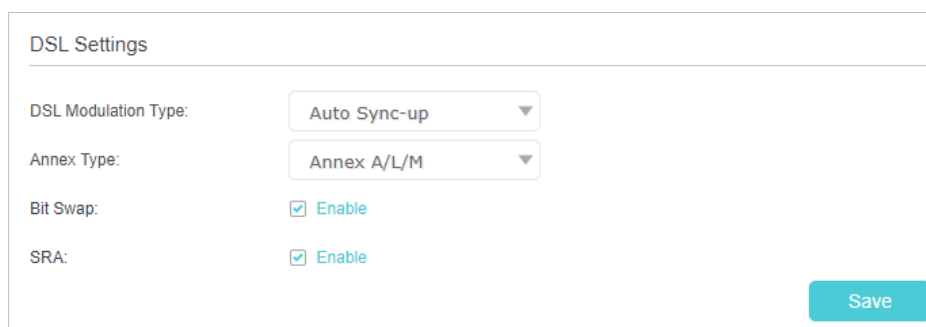

DSL Settings

DSL Modulation Type: Auto Sync-up

Annex Type: Annex A/L/M

Bit Swap: Enable

SRA: Enable

Save

4. Enable the following functions as needed.

Bit Swap - Select this checkbox to enable the Bit Swap feature. With bit-swapping, the router can swap bits around different channels, allowing it to robustly adapt to changing telephone line conditions.

SRA - Select this checkbox to enable the SRA (Seamless Rate Adaptation) feature that prevents ADSL data rate interference caused by the cross-talk between telephone lines.

6.4. Set Up a Dynamic DNS Service Account

Most ISPs (Internet service providers) assign a dynamic IP address to the router and you can use this IP address to access your router remotely. However, the IP address can change any time and you don't know when it changes. In this case, you might need the DDNS (Dynamic Domain Name Server) feature on the router to allow you and your friends to access your router and local servers (FTP, HTTP, etc.) using domain name, in no need of checking and remembering the IP address.

Note: DDNS does not work if the ISP assigns a private WAN IP address (such as 192.168.1.x) to the router.

To set up DDNS, please follow the instructions below:

1. Visit <http://tplinkmodem.net> or <http://192.168.1.1>, and log in with the password you set for the modem router.
2. Go to [Advanced](#) > [Network](#) > [Dynamic DNS](#).

3. Select the [Service Provider](#) (TP-Link/Dyndns/NO-IP).
4. Log in with your DDNS account, select a service provider. Enter the username, password and domain name of the account (such as lisa.ddns.net).

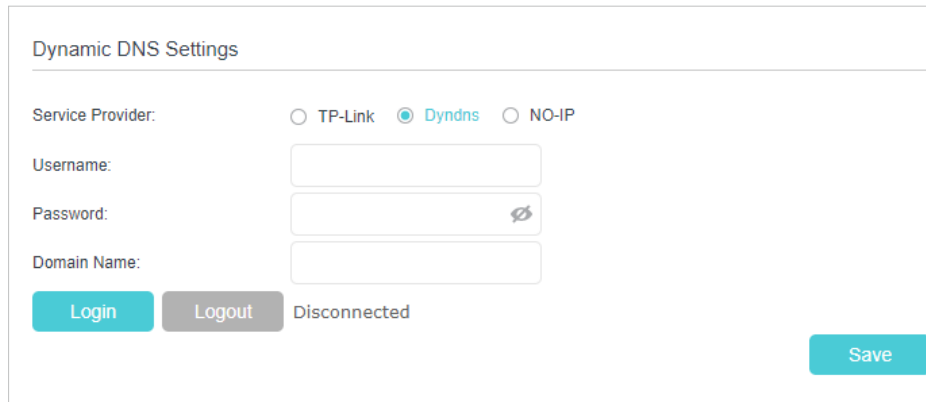

5. Click [Log in](#) and [Save](#).

 **Tips:** If you want to use a new DDNS account, please log out first, then log in with the new account.

6.5. Create Static Routes

A static route is a pre-determined path that network information must travel to reach a specific host or network. Data from one point to another will always follow the same path regardless of other considerations. Normal internet usage does not require this setting to be configured.

I want to:

Visit multiple networks and multiple servers at the same time.

[For example](#), in a small office, my PC can surf the internet through Modem Router A, but I also want to visit my company's network. Now I have a switch and another Modem Router B. I connect the devices as shown in the following image so that the physical connection between my PC and my company's server is established. To surf the internet and visit my company's network at the same time, I need to configure the static routing.

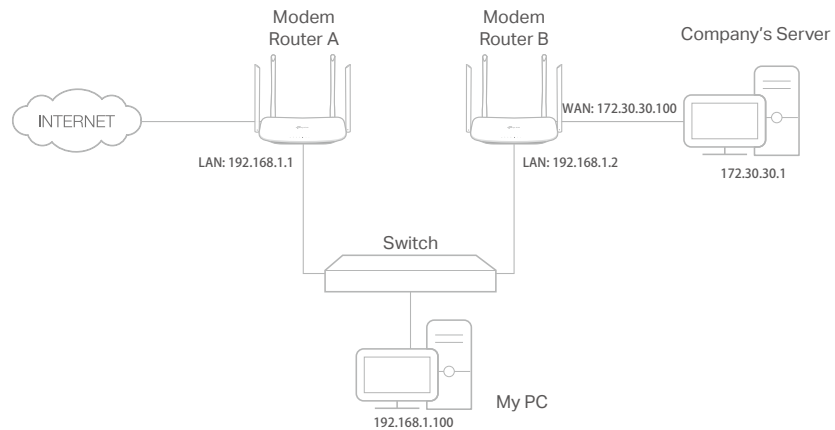

How can I do that?

1. Make sure the routers use different LAN IP addresses on the same subnet. Disable Modem Router B's DHCP function.
2. Visit <http://tplinkmodem.net> or <http://192.168.1.1>, and log in with the password you set for the Modem Router A.
3. Go to **Advanced > Network > Static Routing**. Select your current **WAN Interface** and click **Save**.

Default Gateway Settings IPv4 | IPv6

Select a WAN interface as the system default gateway.

Select WAN Interface: Save

Static Routing + Add - Delete

	ID	Network Destination	Subnet Mask	Gateway	Status	Modify
<input type="checkbox"/>	--	--	--	--	--	--

4. Click **Add** to add a new static routing entry. Finish the settings according to the following explanations:

Static Routing

<input type="checkbox"/>	ID	Network Destination	Subnet Mask	Gateway	Status	Modify
–	–	–	–	–	–	–

Network Destination: 172 . 30 . 30 . 1
 Subnet Mask: 255 . 255 . 255 . 255
 Gateway: 192 . 168 . 0 . 2
 Interface: LAN

Enable This Entry

Cancel Save

- **Network Destination:** The destination IP address that you want to assign to a static route. This IP address cannot be on the same subnet with the WAN IP or LAN IP of the Router A. In the example, the IP address of the company network is the destination IP address, so here we enter 172.30.30.1.
 - **Subnet Mask:** Determines the destination network with the destination IP address. If the destination is a single IP address, enter 255.255.255.255; otherwise, enter the subnet mask of the corresponding network IP. In the example, the destination network is a single IP, so here we enter 255.255.255.255.
 - **Gateway:** The IP address of the gateway device to which the data packets will be sent. This IP address must be on the same subnet with the router's IP which sends out the data. In the example, the data packets will be sent to the LAN port of Router B and then to the Server, so the default gateway should be 192.168.1.2.
 - **Interface:** Determined by the port (WAN/LAN) that sends out the data packets. In the example, the data is sent to the gateway through the LAN port of Router A, so LAN should be selected.
5. Select the **Enable This Entry** check box to enable this entry.
 6. Click **Save** to make the settings effective.

Done!

Open a web browser on your PC. Enter the company server's IP address to visit the company network.

6.6. RIP Settings

To activate RIP for the WAN interface, select the desired RIP version and operation and place a check in the 'Enabled' checkbox. To stop RIP on the WAN Interface, uncheck the 'Enabled' checkbox. Click the 'Save' button to start/stop RIP and save the configuration.

1. Visit <http://tplinkmodem.net> or <http://192.168.1.1>, and log in with the password you set for the modem router.
2. Go to [Advanced](#) > [Network](#) > [RIP Settings](#).
3. Configure RIP settings.

RIP Settings

To activate RIP for the WAN interface, select the desired RIP version and operation and place a check in the 'Enabled' checkbox. To stop RIP on the WAN Interface, uncheck the 'Enabled' checkbox. Click the 'Save' button to start/stop RIP and save the configuration.

NOTE: RIP cannot be configured on the WAN interface which has NAT enabled.

MD5 Authentication: **Enable**

MD5 Key ID 0:

MD5 Key ID 1:

[Save](#)

Interface	Version	AcceptRA	SendRA	Enabled	RipngEnabled	Modify
--	--	--	--	--	--	--

- **MD5 Authentication** - Enable MD5 Authentication to enhance the rip RA packets security.
- **MD5 Key ID 0** - Setting the MD5 Key ID 0 value.
- **MD5 Key ID 1** - Setting the MD5 Key ID 1 value.
- **Interface** - The WAN interface name of the RIP rule table's entry used in.
- **Version** - The RIP version (RIPv1/RIPv2) of the RIP rule table's entry used.
- **AcceptRA** - Enable it to make the RIP rule entry can accept the Router Advertisement.
- **SendRA** - Enable it to make the RIP rule entry can send the Router Advertisement.
- **Enabled** - Enable it to make the RIP rule entry active for IPv4.
- **RipngEnabled** - Enable it to make the RIP rule entry active for IPv6, which is also known as Ripng.
- **Modify** - Click here to modify the RIP rule entry.

6.7. Specify Wireless Settings

6.7.1. Change Basic Wireless Settings

The modem router's wireless network name (SSID) and password, and security option are preset in the factory. The preset SSID and password can be found on the product label. You can customize the wireless settings according to your needs.

Visit <http://tplinkmodem.net> or <http://192.168.1.1>, and log in with the password you set for the modem router.

➤ **To enable or disable the wireless function:**

1. Go to [Basic](#) > [Wireless](#).
2. The wireless radio is enabled by default. If you want to disable the wireless function of the router, just clear the [Enable](#) check boxes. In this case, all the wireless settings will be invalid.

➤ **To change the wireless network name (SSID) and wireless password:**

1. Go to [Basic](#) > [Wireless](#).
2. Enter a new SSID (32 characters at most) in the [Network Name \(SSID\)](#) field and a new password in the [Password](#) field and click [Save](#). The SSID and password are case-sensitive.

📌 **Note:**

If you use a wireless device to change the wireless settings, you will be disconnected after the new settings are effective. Please write down the new SSID and password for future use.

➤ **To hide SSID:**

1. Go to [Basic](#) > [Wireless](#).
2. Select [Hide SSID](#), and your SSID will not be broadcast. Your SSID won't display on your wireless devices when you scan for local wireless networks and you need to manually join the network.

➤ **To change the mode or channel:**

1. Go to [Advanced](#) > [Wireless](#) > [Wireless Settings](#).

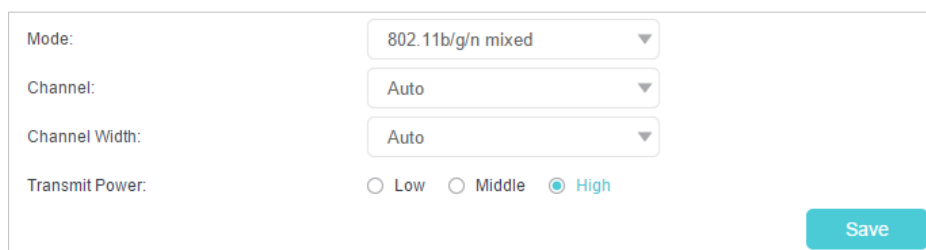

The screenshot shows a configuration panel for wireless settings. It includes four rows of controls: 'Mode' with a dropdown menu set to '802.11b/g/n mixed'; 'Channel' with a dropdown menu set to 'Auto'; 'Channel Width' with a dropdown menu set to 'Auto'; and 'Transmit Power' with three radio buttons: 'Low', 'Middle', and 'High', where 'High' is selected. A blue 'Save' button is located at the bottom right of the panel.

2. Select the wireless network mode or channel and click [Save](#) to make the settings effective.

Mode: Select the desired transmission mode.

- 802.11b/g/n mixed: Select if you are using a mix of 802.11b, 11g, and 11n wireless clients.
- 802.11b/g/n/ax mixed: Select if you are using a mix of 802.11b, 11g, 11n and 11ax wireless clients.
- 802.11a/n/ac mixed: Select if you are using a mix of 802.11a, 11n, and 11ac wireless clients.
- 802.11a/n/ac/ax mixed: Select if you are using a mix of 802.11a, 11n, 11ac and 11ax wireless clients.

Note: When 802.11n only mode is selected, only 802.11n wireless stations can connect to the router. It is strongly recommended that you select 802.11b/g/n mixed (for 2.4GHz) and 802.11a/n/ac/ax mixed (for 5GHz), and all of 802.11a, 802.11b, 802.11g, 802.11n, 802.11ac, and 802.11ax wireless stations can connect to the router.

Channel: Select the channel you want to use from the drop-down list. This field determines which operating frequency will be used. It is not necessary to change the wireless channel unless you notice interference problems with another nearby access point.

Channel Width: Select the channel width from the drop-down list. The default setting is [Auto](#), which can adjust the channel width for your clients automatically.

Transmit Power: Select Low, Middle, or High to specify the data transmit power. The default and recommended setting is [High](#).

➤ **To change the security option:**

1. Go to [Advanced](#) > [Wireless](#) > [Wireless Settings](#).

The screenshot shows the 'Wireless Settings' configuration page. It includes the following fields and options:

- Security:** A dropdown menu set to 'WPA2-PSK[AES]'.
- Password:** A text input field containing '90844195'.
- Transmit Power:** Three radio buttons labeled 'Low', 'Middle', and 'High'. The 'High' option is selected.
- Mode:** A dropdown menu set to '802.11b/g/n/ax mixed'.
- Channel:** A dropdown menu set to 'Auto'.
- Channel Width:** A dropdown menu set to 'Auto'.
- Transmit Power:** Radio buttons for 'Low', 'Middle', and 'High'. 'High' is selected.
- Save:** A blue button at the bottom right.

2. Select an option from the [Security](#) drop-down list and configure the related parameters. The router provides four options, No Security, WPA-PSK[TKIP]+WPA2-PSK[AES], WPA2-PSK[AES], WPA2-PSK[AES]+WPA3-Personal. WPA3 uses the

newest standard and the security level is the highest. We recommend you don't change the default settings unless necessary.

3. Click [Save](#) to make the settings effective.

➤ **To enable network roaming:**

Network roaming helps devices choose better AP based on actual conditions to balance network demands.

1. Go to [Advanced](#) > [Wireless](#) > [Wireless Settings](#).
2. Locate the [Band Steering](#) section, select the [Enable](#) check box to make the settings effective.

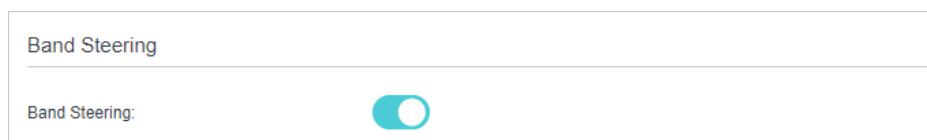

6.7.2. Advanced Wireless Settings

Advanced wireless settings are for those who want more network controls. You can follow the instructions below to configure your router.

1. Visit <http://tplinkmodem.net> or <http://192.168.1.1>, and log in with the password you set for the modem router.
2. Go to [Advanced](#) > [Wireless](#) > [Advanced Settings](#).

➤ **To change basic advanced settings:**

Locate the [Advanced Settings](#) section and configure the advanced settings according to the explanation below, and then click [Save](#).

Advanced Settings		2.4GHz 5GHz
Beacon Interval:	<input type="text" value="100"/>	(40-1000)
RTS Threshold:	<input type="text" value="2346"/>	(1-2346)
DTIM Interval:	<input type="text" value="1"/>	(1-255)
Group Key Update Period:	<input type="text" value="0"/>	seconds
WMM:	<input checked="" type="checkbox"/> Enable	
Short GI:	<input checked="" type="checkbox"/> Enable	
AP Isolation:	<input type="checkbox"/> Enable	
Air time fairness:	<input type="checkbox"/> Enable	
Fast Roaming (802.11r):	<input type="checkbox"/> Enable	
Save		

- **Beacon Interval:** Enter a value between 40 and 1000 in milliseconds to determine the duration between which beacon packets are broadcast by the router to synchronize the wireless network. The default is 100 milliseconds.
- **RTS Threshold:** Enter a value between 1 and 2346 to determine the packet size of data transmission through the router. By default, the RTS (Request to Send) Threshold size is 2347. If the packet size is greater than the preset threshold, the router sends Request to Send frames to a particular receiving station and negotiates the sending of a data frame, or else the packet will be sent immediately.
- **DTIM Interval:** Enter a value between 1 and 255 to determine the interval of the Delivery Traffic Indication Message (DTIM). 1 indicates the DTIM Interval is the same as **Beacon Interval**.
- **Group Key Update Period:** Enter the number of seconds to control the time interval for the encryption key automatic renewal. The default is 0, indicating no key renewal.
- **WMM:** This feature guarantees the packets with high-priority messages being transmitted preferentially. WMM is enabled compulsively under 802.11n or 802.11ac mode.
- **Short GI:** This feature is enabled by default and recommended to increase the data capacity by reducing the Guard Interval (GI) time.
- **AP Isolation:** Select this check box to enable the AP Isolation feature that allows you to confine and restrict all wireless devices on your network from interacting with each other, but still able to access the internet.
- **Air time fairness:** Select this checkbox to enable the Airtime Fairness(ATF) feature that allows you to optimize the throughput of each flow. The ATF traffic scheduler uses the per-destination airtime targets to balance airtime usage across flow destinations.
- **Fast Roaming (802.11r):** This feature allows a client device to roam quickly in environments implementing the WPA2 Enterprise security, by ensuring that the client device does not need to re-authenticate to the RADIUS server every time it roams from one access point to another. It's recommended that you keep the feature enabled for better roaming experiences.

Note:

If you are not familiar with the settings mentioned above, it's strongly recommended that you keep the provided default settings; otherwise it may result in lower wireless network performance.

➤ **To enable or disable WPS function:**

WPS (Wi-Fi Protected Setup) provides you with an easier approach to set up a security-protected Wi-Fi connection. This function is enabled by default, but if you do not need this function, clear the WPS **Enable** check box.

1. Visit <http://tplinkmodem.net> or <http://192.168.1.1>, and log in with the password you set for the modem router.

2. Go to [Advanced](#) > [Wireless](#) > [WPS](#).

Router PIN

Other devices can connect to this Router by WPS with the Router's PIN code.

Enable Router's PIN:

Router's PIN:

WPS Settings

Enable WPS:

Select a setup method:

Push Button (Recommended)

Press the physical "push button" on the router or click the "Connect" button on this page.

Failed to add the device!

PIN Number

➤ **To create multi-SSID network:**

The router supports additional up to three multi-SSID wireless networks for client access in each wireless band. You can specify the access and security settings to ensure network security and privacy according to your situation.

1. Visit <http://tplinkmodem.net> or <http://192.168.1.1>, and log in with the password you set for the modem router.
2. Go to [Advanced](#) > [Wireless](#) > [Multi-SSID](#).
 - 1) Locate the [Multi-SSID](#) section, and enable [2.4GHz](#) or [5GHz](#) to open the corresponding setup page.
 - 2) Select the [Enable MSSID 1](#) or [2](#) check box(es) to enable the corresponding multi-SSID network.

Multi-SSID 2.4GHz 5GHz

MSSID1: Enable

Network Name (SSID): Hide SSID

Security:

See each other: Allow guests to see each other

USB Storage Sharing: Allow guests to access my USB Storage Sharing

MSSID2: Enable

Network Name (SSID): Hide SSID

Security:

See each other: Allow guests to see each other

USB Storage Sharing: Allow guests to access my USB Storage Sharing

- 3) Enter a new **Network Name (SSID)** or use the default name, this field is case sensitive. Don't select **Hide SSID** unless you want your guests to manually input the SSID for Wi-Fi access.
- 4) Select the **Security** option for the multi-SSID network, **WPA/WPA2 Personal** is recommended, and you can set a password for the network.
 If you want to allow the clients in your Multi-SSID network to communicate with each other via methods such as Network Neighborhood and Ping, select the **Allow Guests to See Each Other** check box.
 If you want to allow the clients in your Multi-SSID network to access your router's USB storage sharing via methods such as Network Neighborhood and FTP, select the **Allow Guests to Access My USB Storage Sharing** check box.
- 5) Repeat step 1) to step 4) to set other wireless networks if needed, and click **Save** to make the settings effective.

6.7.3. View Wireless Information

➤ **To view the detailed wireless network settings:**

1. Visit <http://tplinkmodem.net> or <http://192.168.1.1>, and log in with the password you set for the modem router.
2. Go to **Advanced > Status** page. You will find the **Wireless** panel.
3. Click **2.4GHz** or **5GHz** to view the wireless details.

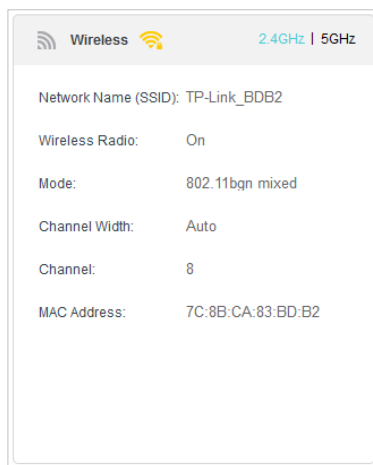

🔗 **Tips:** You can also see the wireless details by clicking the router icon on [Basic > Network Map](#).

➤ **To view the detailed information of the connected wireless clients:**

1. Visit <http://tplinkmodem.net> or <http://192.168.1.1>, and log in with the password you set for the modem router.
2. Go to [Advanced > Wireless > Statistics](#) page.
3. You can view the detailed information of the wireless clients, including its connection type and security option as well as the packets transmitted.

🔗 **Tips:** You can also see the wireless details by clicking the wireless clients icon on [Basic > Network Map](#).

6.8. Schedule Your Wireless Function

You can automatically turn off your wireless networks when you do not need the wireless connection.

1. Visit <http://tplinkmodem.net> or <http://192.168.1.1>, and log in with the password you set for the modem router.
2. Go to [Advanced > Wireless > Wireless Schedule](#).
3. Enable the [Wireless Schedule](#) function.

Wireless Schedule

Wireless Schedule:

	Sun	Mon	Tue	Wed	Thu	Fri	Sat
0:00							
1:00							
2:00							
3:00							
4:00							
5:00							
6:00							
7:00							
8:00							
9:00							
10:00							
11:00							
12:00							
13:00							
14:00							
15:00							
16:00							
17:00							
18:00							
19:00							
20:00							
21:00							
22:00							
23:00							
24:00							

■ Wi-Fi Off

Restore Save

4. Click [Add](#) to set the [Wireless Off Time](#), and click [Save](#) to make the settings effective.

Note:

1. Make sure that the time of the router is correct before using this function. For details, refer to [Set System Time](#).
2. The wireless LED will turn off if the corresponding wireless network is disabled.
3. The wireless network will be automatically turned on after the time period you set.

6.9. Use WPS for Wireless Connection

You can use WPS (Wi-Fi Protected Setup) to add a new wireless device to your existing network quickly and easily.

Method 1: Use the WPS button

Use this method if your client device has a WPS button.

1. Press the WiFi/WPS button of the router.
2. Press the WPS button of the client device directly.
3. The WPS LED flashes for about 2 minutes during the WPS process.

4. When the WPS LED is on, the client device has successfully connected to the router.

Method 2: Use the “Connect” button on the web management page

Use this method if your client device has a WPS button.

1. Visit <http://tplinkmodem.net> or <http://192.168.1.1>, and log in with the password you set for the modem router.
2. Go to [Advanced](#) > [Wireless](#) > [WPS](#) page.

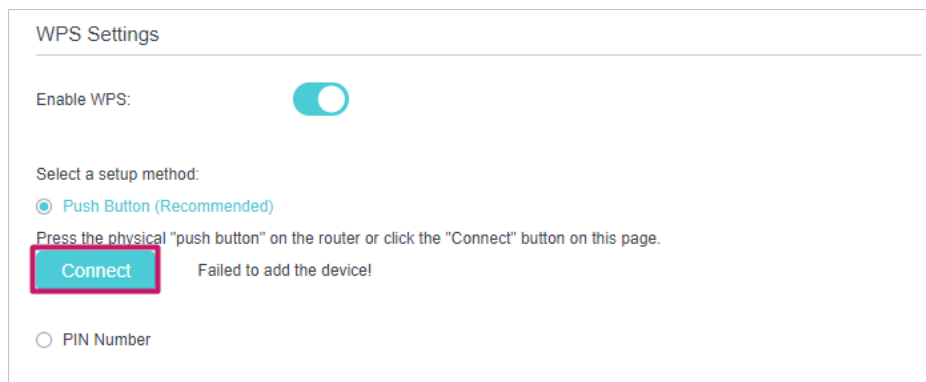

WPS Settings

Enable WPS:

Select a setup method:

Push Button (Recommended)

Press the physical "push button" on the router or click the "Connect" button on this page.

Failed to add the device!

PIN Number

3. Click [Connect](#) on the page.
4. Press the WPS button of the client device directly.
5. The WPS LED of the router flashes for about 2 minutes during the WPS process.
6. When the WPS LED is on, the client device has successfully connected to the router.

Method 3: Enter the router's PIN on your client device

Use this method if your client device asks for the router's PIN.

1. Visit <http://tplinkmodem.net> or <http://192.168.1.1>, and log in with the password you set for the modem router.
2. Go to [Advanced](#) > [Wireless](#) > [WPS](#), and enable [Router's PIN](#).

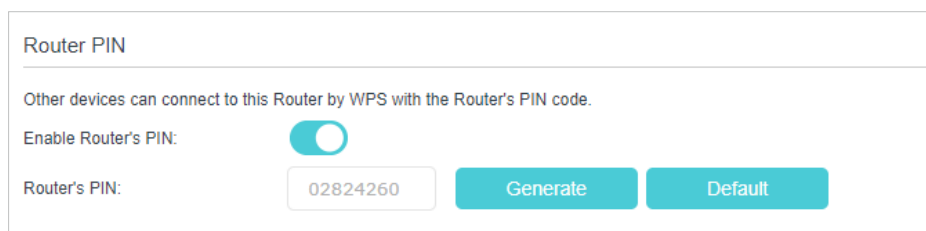

Router PIN

Other devices can connect to this Router by WPS with the Router's PIN code.

Enable Router's PIN:

Router's PIN:

3. Take a note of the current PIN of the router. You can also click the [Generate](#) button to get a new PIN.
4. Enter the router's PIN on the client device. (The default PIN is also printed on the label of the router.)
5. The WPS LED flashes for about 2 minutes during the WPS process.
6. When the WPS LED is on, the client device has successfully connected to the router.

■ **Note:**

1. The WPS LED on the router will light on for five minutes if the device has been successfully added to the network.
2. The WPS function cannot be configured if the wireless function of the router is disabled. Please make sure the wireless function is enabled before configuring WPS.

Method 4: Enter the client device's PIN on the router

1. Visit <http://tplinkmodem.net> or <http://192.168.1.1>, and log in with the password you set for the modem router.
2. Go to [Advanced](#) > [Wireless](#) > [WPS](#), and click [PIN Number](#).
3. Enter the [Client's PIN](#).

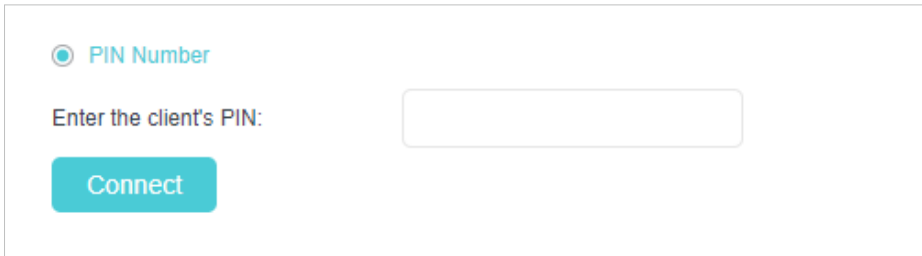

● [PIN Number](#)

Enter the client's PIN:

[Connect](#)

4. Then click the [Connect](#) button.
5. [Device has been added successfully!](#) or the similar information will appear on the web page, which means the client device has successfully connected to the router.

6. 10. Configure MAC Filter Settings

You can toggle on to control wireless access using the MAC address of individual devices.

1. Visit <http://tplinkmodem.net> or <http://192.168.1.1>, and log in with the password you set for the modem router.
2. Go to [Advanced](#) > [Wireless](#) > [MAC Filter](#).
3. Enable the [Wireless MAC Filtering](#) function.

MAC Filter Settings

Wireless MAC Filtering:

Note: Enable this function may effect stations connect to AP using WPS when these stations' MAC are not acceptable.

➤ **To select a filtering rule:**

Filtering Rules

Select a filtering rule:

Block wireless access from the devices in the list below.

Allow wireless access only from the devices in the list below.

[Save](#)

- **Block wireless access from the devices in the list below.:** Select to block wireless access from the devices in the list below.
- **Allow wireless access only from the devices in the list below.:** Select to allow wireless access only from the devices in the list below.

➤ **To add a new device:**

1. linkmodem.net or <http://192.168.1.1>, and log in with the password you set for the modem router.
2. Go to [Advanced](#) > [Wireless](#) > [MAC Filter](#) > [Devices List](#).
3. Click [Add](#). Enter the [MAC Address](#) and a [Description](#) of the device.

Devices List

[+ Add](#) [- Delete](#)

<input type="checkbox"/>	ID	MAC Address	Description	Enable	Modify
--	--	--	--	--	--

MAC Address:

Description:

[Enable this Entry](#)

[Cancel](#) [OK](#)

4. Click [Enable this Entry](#) and [OK](#).

➤ **To block one or multiple devices:**

In the [Devices Online](#) table, select the devices that you wish to block, click [Block](#) above the table. The selected devices will be automatically added to the [Devices in Blocklist](#).

Devices Online

[Refresh](#) [Block](#)

<input type="checkbox"/>	ID	Device Name	IP Address	MAC Address	Connection Type
--	--	--	--	--	--

- **Device Name:** Displays the name of the connected device.
- **IP Address:** Displays the IP address of the connected device.
- **MAC Address:** Displays the MAC address of the connected device.
- **Connection Type:** Displays the connection type of the connected device, either wired or wireless.

Chapter 7

Multi-SSID

Multi-SSID function allows you to provide Wi-Fi access for your visitors without disclosing your main network. When you have guests in your house, apartment, or workplace, you can create a multi-SSID wireless network for them. In addition, you can customize the network settings to ensure your network security and privacy.

➤ **To create a multi-SSID network:**

1. Visit <http://tplinkmodem.net> or <http://192.168.1.1>, and log in with the password you set for the modem router.
2. Go to [Basic > Multi-SSID](#) or [Advanced > Wireless > Multi-SSID](#).
3. Create the multi-SSID network as needed.

Multi-SSID 2.4GHz | 5GHz

MSSID1: Enable

Network Name (SSID): Hide SSID

Security:

See each other: Allow guests to see each other

USB Storage Sharing: Allow guests to access my USB Storage Sharing

MSSID2: Enable

Network Name (SSID): Hide SSID

Security:

See each other: Allow guests to see each other

USB Storage Sharing: Allow guests to access my USB Storage Sharing

- 1) Select the **Enable** check box to create the corresponding multi-SSID network. You can create three multi-SSID wireless networks at most.
 - 2) Enter a new **Network Name (SSID)** or use the default name, this field is case-sensitive. Don't select **Hide SSID** unless you want your guests to manually input the SSID for Wi-Fi access.
 - 3) Select the **Security** option for the multi-SSID wireless network, **WPA/WPA2/WPA3 Personal (Recommended)** is recommended, and you can set a password for the network.
4. Click **Save** to make the settings effective. Now your guests can access your multi-SSID wireless network using the SSID and password specified.

Chapter 8

TP-Link Cloud Service

TP-Link Cloud service provides a better way to manage your cloud devices. Log in to your modem router with a TP-Link ID, and you can easily monitor and manage your home network when you are out and about via the Aginet app. To ensure that your modem router stays new and gets better over time, the TP-Link Cloud will notify you when an important firmware upgrade is available. Surely you can also manage multiple TP-Link Cloud devices with a single TP-Link ID.

This chapter introduces how to register a new TP-Link ID, bind or unbind TP-Link IDs to manage your modem router, and the Aginet app with which you can manage your home network no matter where you may find yourself.

It contains the following sections:

- [Register a TP-Link ID](#)
- [Change Your TP-Link ID Information](#)
- [Manage the User TP-Link IDs](#)
- [Manage the Modem Router via the TP-Link Aginet App](#)

8.1. Register a TP-Link ID

If you have skipped the registration during the Quick Setup process, you can:

1. Visit <http://tplinkmodem.net> or <http://192.168.1.1>, and log in with the password you set for the modem router.
2. Go to [Basic > TP-Link Cloud](#).
3. Click [Sign Up](#) and follow the instructions to register a TP-Link ID.

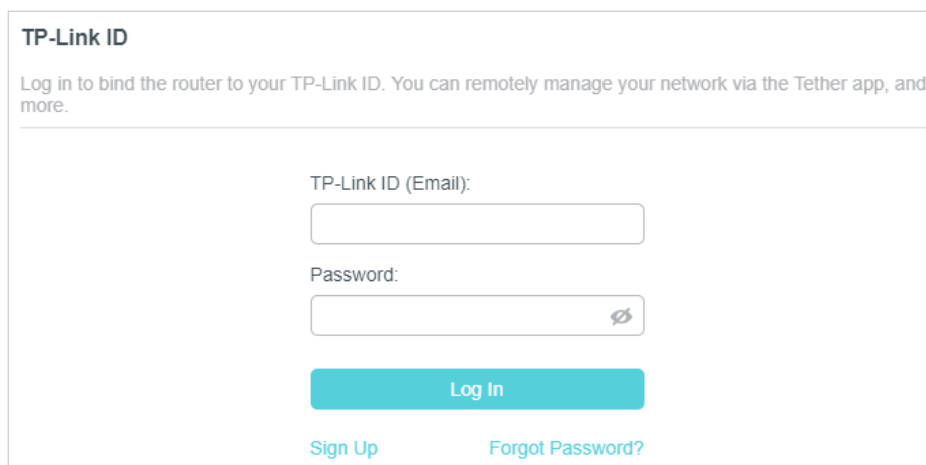

TP-Link ID

Log in to bind the router to your TP-Link ID. You can remotely manage your network via the Tether app, and more.

TP-Link ID (Email):

Password:

[Log In](#)

[Sign Up](#) [Forgot Password?](#)

4. After activating your TP-Link ID, come back to the TP-Link Cloud page to log in. The TP-Link ID used to log in to the router for the first time will be automatically bound as an [Admin](#).

Note:

- To learn more about the [Admin](#) and [User](#) TP-Link ID, refer to [Manage the User TP-Link IDs](#).
- Once you have registered a TP-Link ID on the web management page, you can only register another TP-Link ID via the Aginet APP. Please refer to [Manage the Modem Router via the TP-Link Aginet App](#) to install the app.
- If you want to unbind the admin TP-Link ID from your router, please go to [Basic > TP-Link Cloud](#), and click [Unbind](#) in the [Device Information](#) section.

8.2. Change Your TP-Link ID Information

Follow the steps below to change your email address and password of your TP-Link ID as needed.

1. Visit <http://tplinkmodem.net> or <http://192.168.1.1>, and log in with your TP-Link ID.
2. Go to [Basic > TP-Link Cloud](#), and focus on the [Account Information](#) section.

- **To change your email address:**

1. Click  behind the Email.
2. Enter the password of your TP-Link ID, then a new email address. And click [Save](#).

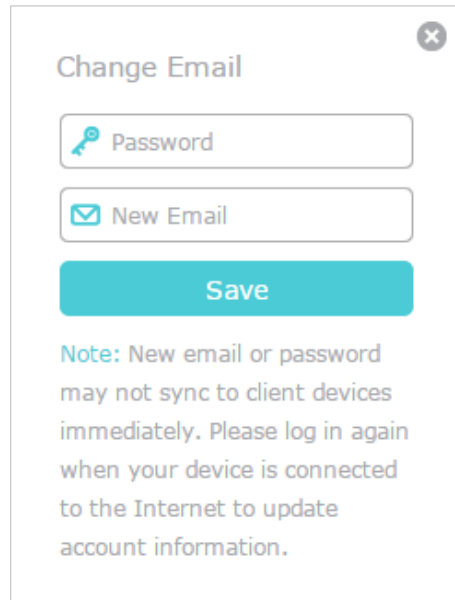

The 'Change Email' dialog box features a title bar with a close button (X). It contains two input fields: 'Password' with a key icon and 'New Email' with an envelope icon. Below these is a teal 'Save' button. A note at the bottom states: 'Note: New email or password may not sync to client devices immediately. Please log in again when your device is connected to the Internet to update account information.'

- **To change your password:**

1. Click  behind the Password.
2. Enter the current password, then a new password twice. And click [Save](#).

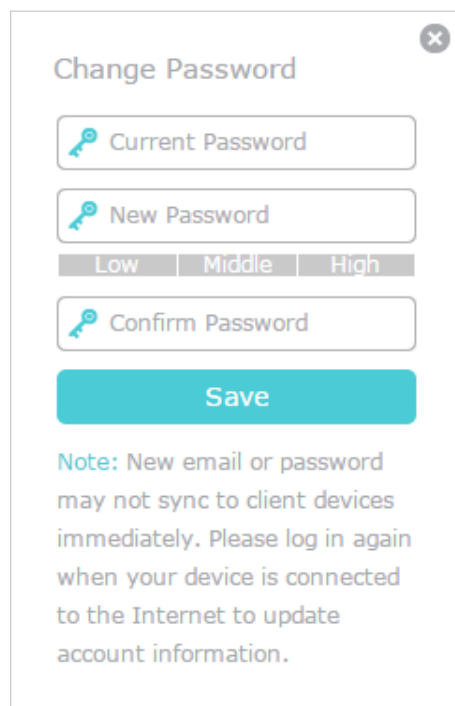

The 'Change Password' dialog box has a title bar with a close button (X). It includes three input fields: 'Current Password', 'New Password', and 'Confirm Password', each with a key icon. The 'New Password' field has a strength indicator below it with 'Low', 'Middle', and 'High' segments. A teal 'Save' button is positioned below the fields. A note at the bottom reads: 'Note: New email or password may not sync to client devices immediately. Please log in again when your device is connected to the Internet to update account information.'

8.3. Manage the User TP-Link IDs

The TP-Link ID used to log in to the modem router for the first time will be automatically bound as the [Admin](#) account. An admin account can add or remove other TP-Link IDs

to or from the same router as **Users**. All accounts can monitor and manage the router locally or remotely, but user accounts cannot:

- Reset the modem router to its factory default settings either on the web management page or in the Aginet app.
- Add/remove other TP-Link IDs to/from the modem router.

8.3.1. Add TP-Link ID to Manage the Modem Router

1. Visit <http://tplinkmodem.net> or <http://192.168.1.1>, and log in with your TP-Link ID.
2. Go to **Basic > TP-Link Cloud**, and focus on the **Bound Accounts** section.
3. Click **+ Bind**, enter another TP-Link ID as needed and click **Save**.

Note: If you need another TP-Link ID, please register a new one via the Aginet app. Refer to [Manage the Modem Router via the TP-Link Aginet App](#) to install the app and register a new TP-Link ID.

4. The new TP-Link ID will be displayed in the Bound Accounts table as a **User**.

Bound Accounts				
+ Bind - Unbind				
<input type="checkbox"/>	ID	Email	Binding Date	Role
<input type="checkbox"/>	1	admin_123@tplink.com	2023-10-27	Admin
<input type="checkbox"/>	2	admin123@tplink.com	2023-10-27	User

8.3.2. Remove TP-Link ID(s) from Managing the Modem Router

1. Visit <http://tplinkmodem.net> or <http://192.168.1.1>, and log in with your TP-Link ID.
2. Go to **Basic > TP-Link Cloud**, and focus on the **Bound Accounts** section.
3. Tick the checkbox(es) of the TP-Link ID(s) you want to remove and click **Unbind**.

Bound Accounts				
+ Bind - Unbind				
<input type="checkbox"/>	ID	Email	Binding Date	Role
<input type="checkbox"/>	1	*****@****.com	****/****/****	Admin
<input checked="" type="checkbox"/>	2	*****@****.com	****/****/****	User

8.4. Manage the Modem Router via the TP-Link Aginet App

The Aginet app runs on iOS and Android devices, such as smartphones and tablets.

1. Launch the Apple App Store or Google Play store and search "TP-Link Aginet" or simply scan the QR code to download and install the app.



2. Launch the Aginet app and log in with your TP-Link ID.

Note: If you don't have a TP-Link ID, create one first.

3. Connect your device to the modem router's wireless network.
4. Go back to the Aginet app, select the model of your router and log in with the password you set for the router.
5. Manage your router as needed.

Note: If you need to remotely access your router from your smart devices, you need to:

- Log in with your TP-Link ID. If you don't have one, refer to [Register a TP-Link ID](#).
- Make sure your smartphone or tablet can access the internet with cellular data or a Wi-Fi network.

Chapter 9

USB Settings

This chapter describes how to use the USB ports to share files and media from the USB storage devices over your home network locally, or remotely through the internet.

The modem router supports USB external flash drives and hard drives.

It contains the following sections:

- [Access the USB Storage Device](#)
- [Media Sharing](#)
- [3G/4G Settings](#)

9.1. Access the USB Storage Device

Insert your USB storage device into the modem router's USB port and then access files stored there locally or remotely.

 **Tips:**

- If you use USB hubs, make sure no more than 4 devices are connected to the modem router.
- If the USB storage device requires using bundled external power, make sure the external power has been connected.
- If you use a USB hard drive, make sure its file system is FAT32, exFat, NTFS or HFS+.
- Before you physically disconnect a USB device from the router, safely remove it to avoid data damage: Go to [Advanced > USB Sharing > USB Storage Device](#) and click [Remove](#).

9.1.1. Access the USB Device Locally

Insert your USB storage device into the modem router's USB port and then refer to the following table to access files stored on your USB storage device.

Windows computer

- **Method 1:**

Go to [Computer > Network](#), then click the Network Server Name ([TP-SHARE](#) by default) in the [Computer](#) section.

 **Note:**

Operations in different systems are similar. Here we take Windows 7 as an example.

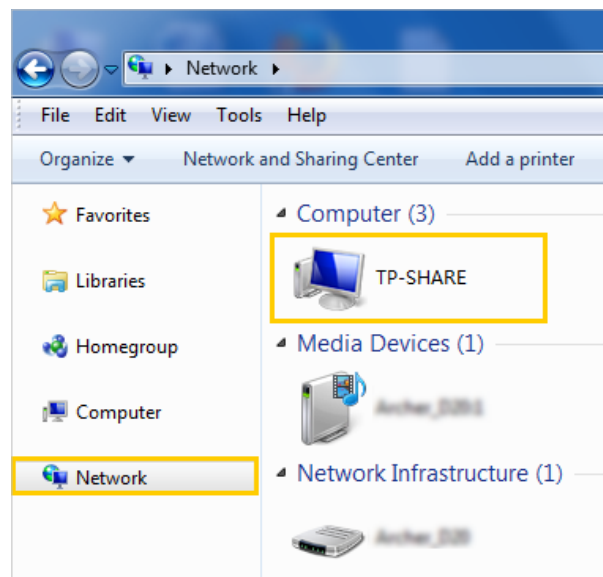

Windows
computer

- **Method 2:**

Open the [Windows Explorer](#) (or go to [Computer](#)) and type the server address `\\tplinkwifi.net` or `ftp://tplinkwifi.net` in the address bar, then press [Enter](#).

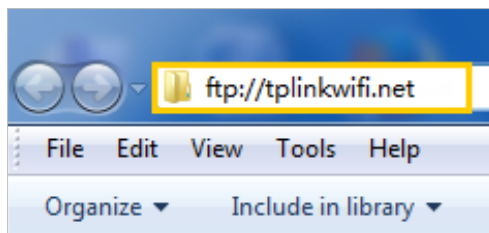

Mac

- 1) Select [Go > Connect to Server](#).
- 2) Type the server address `smb://tplinkwifi.net`.
- 3) Click [Connect](#).

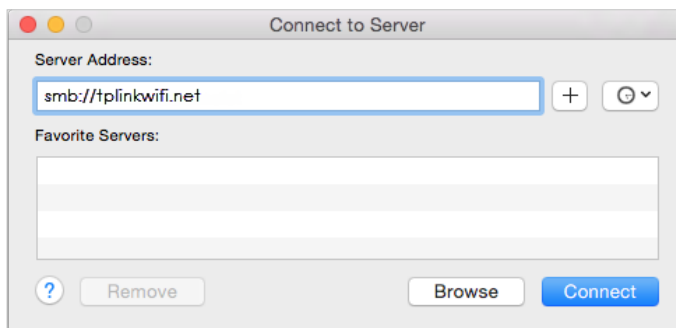

- 4) When prompted, select the [Guest](#) radio box. (If you have set up a username and a password to deny anonymous access to the USB disks, you should select the [Registered User](#) radio box. To learn how to set up an account for the access, refer to [To Set Up Authentication for Data Security](#).)

Tablet

Use a third-party app for network files management.

 **Tips:**

You can also access your USB storage device by using your Network/Media Server Name as the server address. Refer to [To Customize the Address of the USB Storage Device](#) to learn more.

9.1.2. Access the USB Device Remotely

You can access your USB disk outside the local area network. For example, you can:

- Share photos and other large files with your friends without logging in to (and paying for) a photo-sharing site or email system.
- Get a safe backup for the materials for a presentation.
- Remove the files on your camera's memory card from time to time during the journey.

Note:

If your ISP assigns a private WAN IP address (such as 192.168.x.x or 10.x.x.x), you cannot use this feature because private addresses are not routed on the internet.

Follow the steps below to configure remote access settings.

1. Visit <http://tplinkmodem.net> or <http://192.168.1.1>, and log in with the password you set for the modem router.
2. Go to **Advanced > USB Sharing > Sharing Access > Sharing Settings**.
3. Tick the **FTP** checkbox, and then click **Save**.

Sharing Settings

Network/Media Server Name:

Enable	Access Method	Access Address	Port
<input checked="" type="checkbox"/>	Media Server	--	--
<input checked="" type="checkbox"/>	Network Neighborhood	\\VX230v	--
<input checked="" type="checkbox"/>	FTP	ftp://192.168.1.1:21	<input type="text" value="21"/>
<input checked="" type="checkbox"/>	FTP(via Internet)	ftp://0.0.0.0:21	21

4. Refer to the following table to access your USB disk remotely.

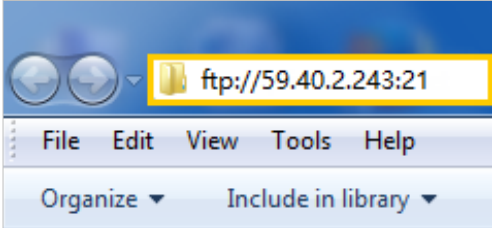
Computer	<ol style="list-style-type: none"> 1) Open the Windows Explorer (or go to Computer, only for Windows users) or open a web browser. 2) Type the server address in the address bar: Type in <code>ftp://<WAN IP address of the router>:<port number></code> (such as <code>ftp://59.40.2.243:21</code>). If you have specified the domain name of the router, you can also type in <code>ftp://<domain name>:<port number></code> (such as <code>ftp://MyDomainName:21</code>) <div data-bbox="644 527 1136 753" style="text-align: center;">  </div> <ol style="list-style-type: none"> 3) Press Enter on the keyboard. 4) Access with the username and password you set in To Set Up Authentication for Data Security. <p>Tips: You can also access the USB disk via a third-party app for network files management, which can resume broken file transfers.</p>
Tablet	<p>Use a third-party app for network files management.</p>

Tips:

Click [Set Up a Dynamic DNS Service Account](#) to learn how to set up a domain name for you router.

9.1.3. Customize the Access Settings

By default, all the network clients can access all folders on your USB disk. You can customize your sharing settings by setting a sharing account, sharing specific contents and setting a new sharing address on the router's web management page.

1. Visit <http://tplinkmodem.net> or <http://192.168.1.1>, and log in with the password you set for the modem router.
2. Go to [Advanced](#) > [USB Sharing](#) > [Sharing Access](#) > [Sharing Settings](#).

- **To Customize the Address of the USB Storage Device**

You can customize the server name and use the name to access your USB storage device.

1. In the [Sharing Settings](#) session, make sure [Media Server](#) is ticked, and enter a [Network/Media Server Name](#) as you like, such as [MyShare](#), then click [Save](#).

Sharing Settings

Network/Media Server Name:

Enable	Access Method	Access Address	Port
<input checked="" type="checkbox"/>	Media Server	--	--
<input checked="" type="checkbox"/>	Network Neighborhood	\\EX510	--
<input checked="" type="checkbox"/>	FTP	ftp://192.168.0.1:21	<input type="text" value="21"/>
<input type="checkbox"/>	FTP(via Internet)	ftp://0.0.0.0:21	21

- Now you can access the USB storage device by visiting <\\MyShare> (for Windows) or <smb://MyShare> (for Mac).

- To Set Up Authentication for Data Security**

You can set up authentication for your USB storage device so that network clients will be required to enter username and password when accessing the USB storage device.

- In the [Sharing Account](#) section, enable [Use New Account](#).

Sharing Account

Content sharing requires a sharing account. You can use the login account or create a new one.

Account: Use Default Account
 Use New Account

Username:

Password:

Confirm Password:

- Modify the access account. The username and password are both [admin](#) for default administrator account, and both [visit](#) for default visitor account. Accessing as an administrator can read and modify the shared folders while visitors can only read the shared folders.

Folder Sharing

Share All:

Enable Authentication:

[Refresh](#)

ID	Folder Name	Folder Path	Volume Name
--	--	--	--

Note:

- For Windows users, do not set the sharing username the same as the Windows username. Otherwise, Windows credential mechanism may cause the following problems:
 - If the sharing password is also the same as the Windows password, authentication will not work since the Windows will automatically use its account information for USB access.
 - If the sharing password is different from the Windows password, the Windows will be unable to remember your credentials and you will always be required to enter the sharing password for USB access.
- Due to Windows credential mechanism, you might be unable to access the USB disk after changing Authentication settings. Please log out from the Windows and try to access again. Or you can change the address of the USB disk by referring to [To Customize the Address of the USB Storage Device](#).

9.2. Media Sharing

The feature of [Media Sharing](#) allows you to view photos, play music and watch movies stored on the USB storage device directly from DLNA-supported devices, such as your computer, tablet and PS2/3/4.

- Visit <http://tplinkmodem.net> or <http://192.168.1.1>, and log in with the password you set for the modem router.
- Go to [Advanced](#) > [USB Sharing](#) > [Sharing Access](#) > [Sharing Settings](#).
- Enable [Media Server](#).

Sharing Settings

Network/Media Server Name:

Enable	Access Method	Access Address	Port
<input checked="" type="checkbox"/>	Media Server	--	--
<input checked="" type="checkbox"/>	Network Neighborhood	\\VX230v	--
<input checked="" type="checkbox"/>	FTP	ftp://192.168.1.1:21	<input type="text" value="21"/>
<input checked="" type="checkbox"/>	FTP(via Internet)	ftp://0.0.0.0:21	21

[Save](#)

4. When your USB storage device is inserted into the router, your DLNA-supported devices (such as your computer and pad) connected to the router can detect and play the media files on the USB storage devices.
5. Refer to the following table for detailed instructions.

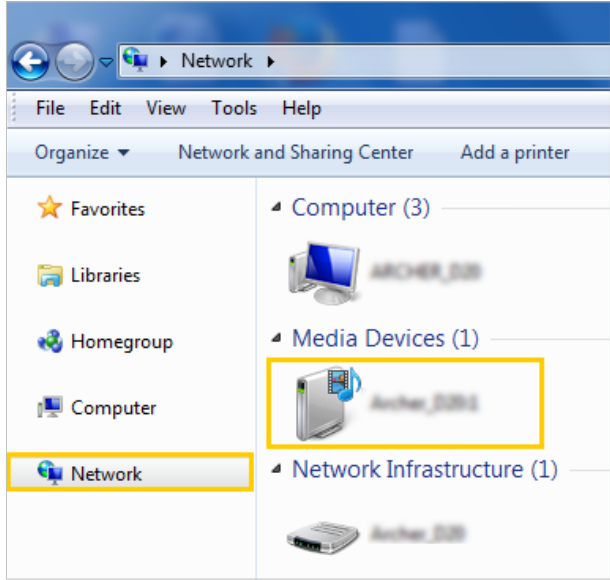
Windows Computer	<ul style="list-style-type: none"> • Go to Computer > Network, then click the Media Server Name (Model number-share by default) in the Media Devices section. <p>Note: Here we take Windows 7 as an example.</p>  <p>The screenshot shows the Windows 7 Network and Sharing Center window. The 'Network' link in the left sidebar is highlighted with a yellow box. In the main pane, the 'Media Devices (1)' section is expanded, and a single device icon is highlighted with a yellow box. The device name is partially visible as 'Archer_2011'.</p>
Tablet	<ul style="list-style-type: none"> • Use a third-party DLNA-supported player.

9.3. 3G/4G Settings

Time Machine backs up all files on your Mac computer to a USB storage device connected to your router.

1. Visit <http://tplinkmodem.net> or <http://192.168.1.1>, and log in with the password you set for the modem router.
2. Go to **Advanced** > **USB Sharing** > **3G/4G Settings**.

3G/4G Settings

Enable 3G/4G as a backup solution for Internet access

3G/4G USB Modem: Unplugged

PIN Status: Unknown

Mobile ISP: Other

Set Dial Number, APN, Username and Password manually

Dial Number:

APN:

Username: (Optional)

Password: (Optional)

Connection Mode: Auto

Max Idle Time: 15 minutes (0 means always active.)

Authentication Type: PAP

Connection Status: Disconnected

Connect Disconnect Disconnected

Advanced

MTU Size (in bytes): 1480 (The default is 1480, do not change unless necessary.)

Echo Request Interval: 30 seconds. (0-120. The default value is 30.)

Use the IP Specified by ISP

Use the Following DNS Addresses

[3G/4G USB Modem Settings](#)

Save

3. Tick the checkbox to enable 3G/4G as a backup solution for Internet access.
4. Tick the checkbox to set the **Dial Number, APN, Username and Password** manually.
Note: The following Advanced settings will only display if you enable 3G/4G as the backup solution for Internet access.
5. Click **Save**.



Chapter 10

EasyMesh with Seamless Roaming

This chapter introduces the TP-Link EasyMesh feature.

It contains the following sections:

- [Set Up a EasyMesh Network](#)
- [Manage Devices in the EasyMesh Network](#)

TP-Link EasyMesh  Controller and TP-Link EasyMesh  Agent work together to form one unified Wi-Fi network. Walk through your home and stay connected with the fastest possible speeds thanks to EasyMesh's seamless coverage.

What's EasyMesh?

EasyMesh implements a standards-based approach, combining easy-to-use, self-adapting Wi-Fi with a flexible design, easy setup, and enhanced network intelligence. In an Mesh network, your mobile device will seamlessly switch between the main Router/Gateway(Controller) and Agents, provides the optimal Wi-Fi connection as you move through your home.



Unified Wi-Fi Network

Controller and agents share the same wireless settings, including network name, password, access control settings and more.

Seamless Roaming

Devices automatically switch between your controller and agents as you move through your home for the fastest possible speeds.

Easy Setup and Management

Set up a EasyMesh network with a push of WPS buttons. Manage all network devices on the Aginet app or at your router's web management page.

10. 1. Set Up a EasyMesh Network

1. Visit <http://tplinkmodem.net> or <http://192.168.1.1>, and log in with the password you set for the modem router.
2. Go to **Basic > Mesh** or **Advanced > Wireless > Mesh**, and enable **EasyMesh**.

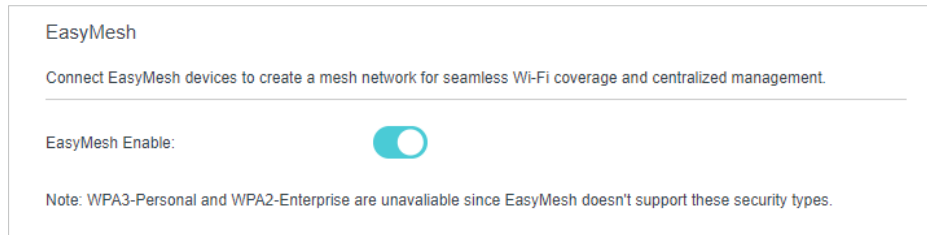

3. Connect a EasyMesh agent to this controller by following the setup instructions in the agent's manual. The agent will be listed on the controller's [Mesh](#) page.

■ Note: To check full list of TP-Link EasyMesh devices, visit <https://www.tp-link.com>.

4. If you have set up the agent to join the EasyMesh network, it will be listed on the controller's [EasyMesh](#) page.

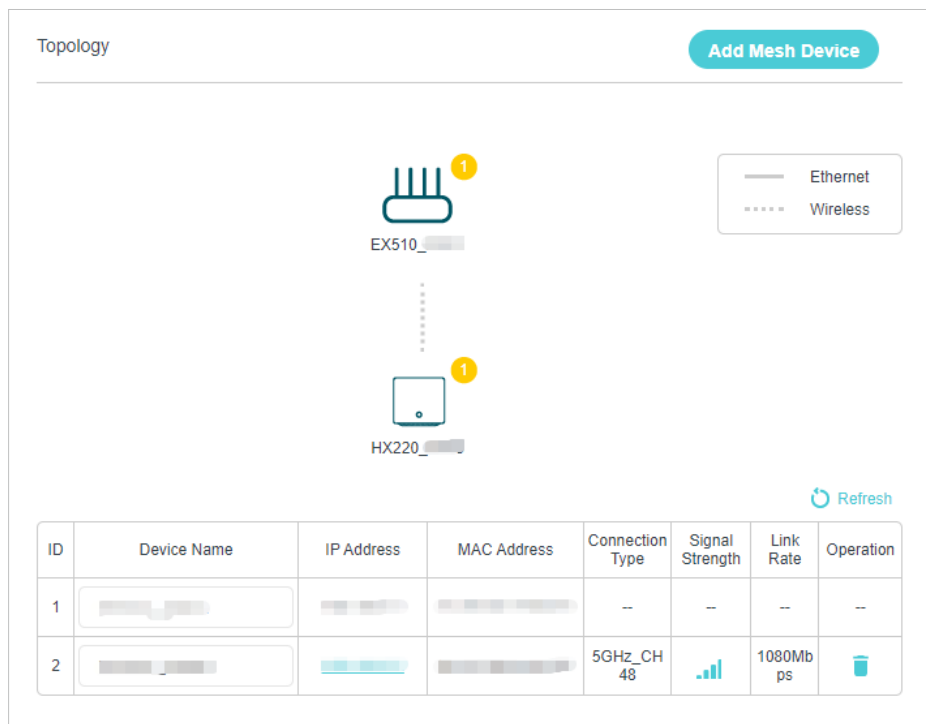

ID	Device Name	IP Address	MAC Address	Connection Type	Signal Strength	Link Rate	Operation
1				--	--	--	--
2				5GHz_CH 48		1080Mbps	

Otherwise, you need to find it in the [Add Mesh Device](#) list and click [Add](#) to add it to the EasyMesh network.

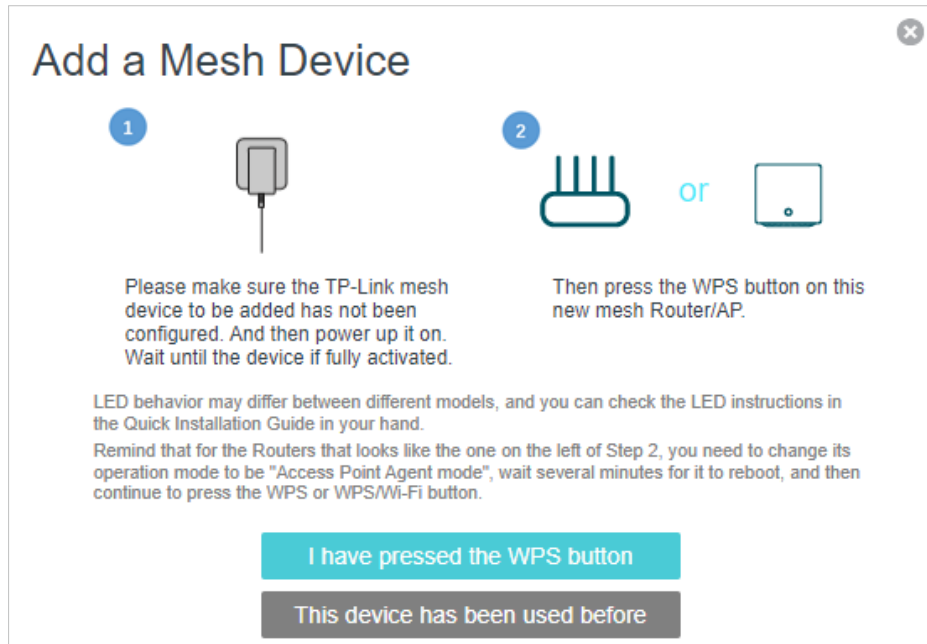

Done! Now your controller and agents successfully form a EasyMesh network!

10.2. Manage Devices in the EasyMesh Network

In a EasyMesh network, you can manage all mesh devices and connected clients on your router's web page.

- **To view mesh devices and connected clients in the network:**

1. Visit <http://tplinkmodem.net> or <http://192.168.1.1>, and log in with the password you set for the modem router.
2. Go to **Basic > Network Map**.
3. Click to view all mesh devices, and click to view all connected clients.

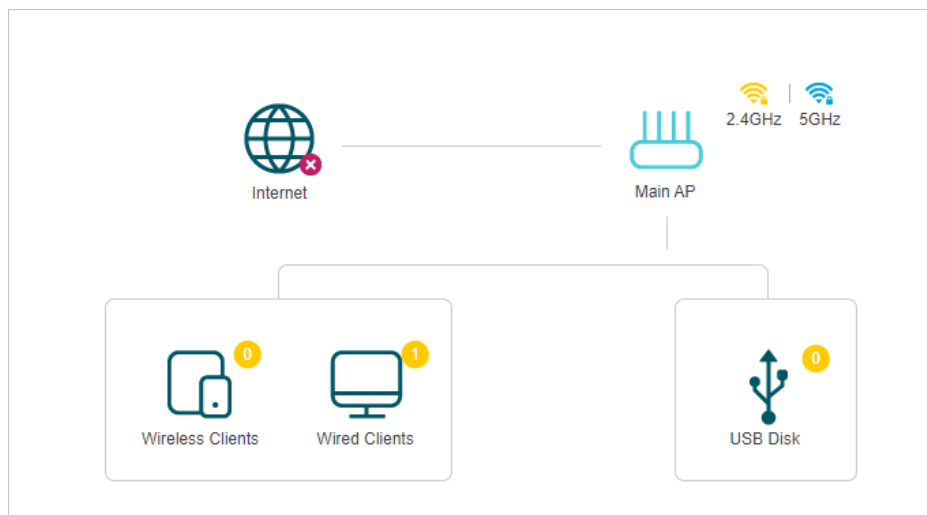

- **To manage a EasyMesh device in the network:**

1. Visit <http://tplinkmodem.net> or <http://192.168.1.1>, and log in with the password you set for the modem router.
2. Go to **Basic > Network Map**.

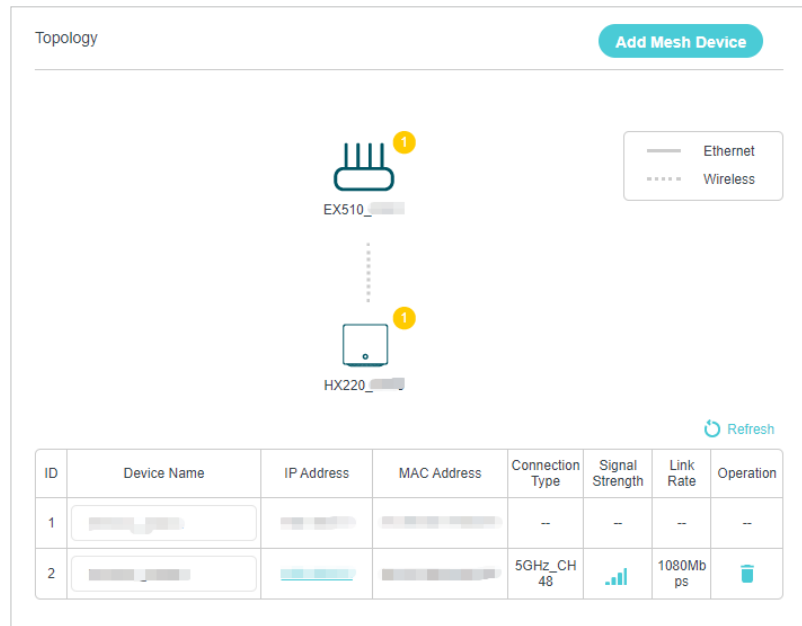

3. Click the Mesh device's IP Address to redirect to the web management page of this device and view detailed information.

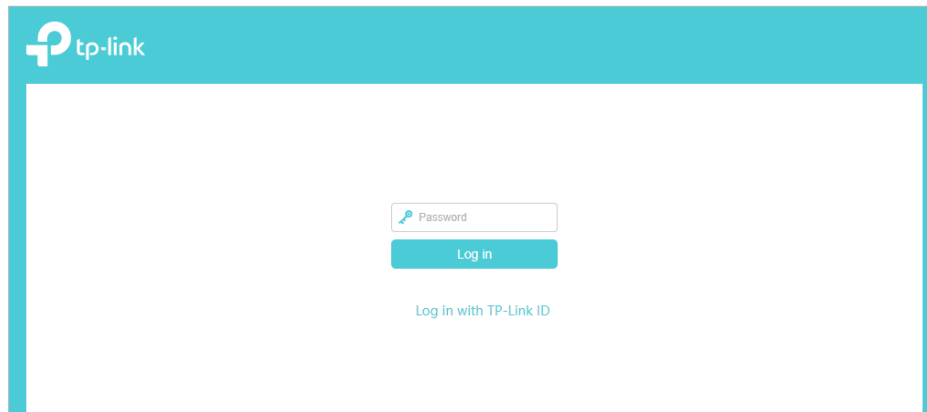

4. Manage the EasyMesh device as needed. You can:

- Change device information.
- Delete this device from the EasyMesh network.

Chapter 11

Guest Network

This function allows you to provide Wi-Fi access for guests without disclosing your main network. When you have guests in your house, apartment, or workplace, you can create a guest network for them. In addition, you can customize guest network options to ensure network security and privacy.

It contains the following sections:

- [Create a Network for Guests](#)
- [Customize Guest Network Options](#)

11.1. Create a Network for Guests

1. Visit <http://tplinkmodem.net> or <http://192.168.1.1>, and log in with the password you set for the modem router.
2. Go to **Advanced** > **Guest Network**. Locate the **Wireless** section.
3. Create a guest network as needed.
 - 1) Tick the **Enable** checkbox for the 2.4GHz or 5GHz wireless network.
 - 2) Customize the SSID. Don't select **Hide SSID** unless you want your guests to manually input the SSID for guest network access.
 - 3) Select the **Security** type and customize your own password. If **No security** is selected, no password is needed to access your guest network.

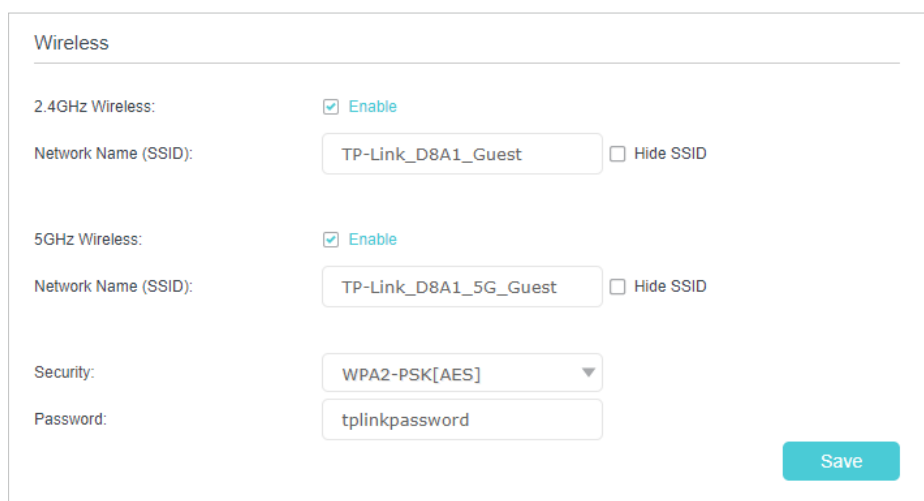

The screenshot displays the 'Wireless' configuration page. It includes sections for 2.4GHz and 5GHz wireless settings. Both are currently enabled. The 2.4GHz SSID is 'TP-Link_D8A1_Guest' and the 5GHz SSID is 'TP-Link_D8A1_5G_Guest'. The security is set to 'WPA2-PSK[AES]' with a password of 'tplinkpassword'. A 'Save' button is located at the bottom right of the form.

4. Click **Save**. Now your guests can access your guest network using the SSID and password you set!

Tips:

To view guest network information, go to **Network Map** and locate the **Guest Network** section. You can turn on or off the guest network function conveniently.

11.2. Customize Guest Network Options

1. Visit <http://tplinkmodem.net> or <http://192.168.1.1>, and log in with the password you set for the modem router.
2. Go to **Advanced** > **Guest Network**. Locate the **Settings** section.
3. Customize guest network options according to your needs.

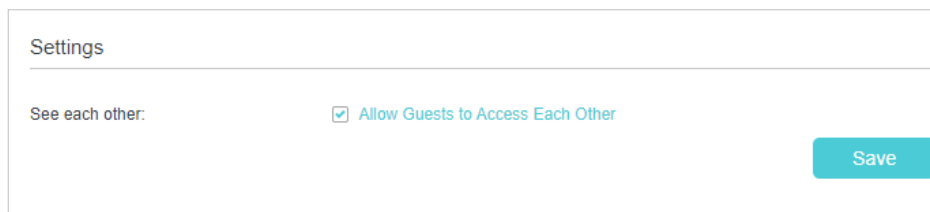

Settings

See each other: Allow Guests to Access Each Other

Save

- [Allow guests to see each other](#)

Tick this checkbox if you want to allow the wireless clients on your guest network to communicate with each other via methods such as network neighbors and Ping.

4. Click [Save](#). Now you can ensure network security and privacy!

Chapter 12

NAT Forwarding

The modem router's NAT (Network Address Translation) feature makes devices on the LAN use the same public IP address to communicate with devices on the internet, which protects the local network by hiding IP addresses of the devices. However, it also brings about the problem that an external host cannot initiatively communicate with a specified device on the local network.

With the forwarding feature the modem router can penetrate the isolation of NAT and allows devices on the internet to initiatively communicate with devices on the local network, thus realizing some special functions.

The TP-Link modem router supports four forwarding rules. If two or more rules are set, the priority of implementation from high to low is Port Forwarding, Port Triggering, UPnP and DMZ.

It contains the following sections:

- [ALG](#)
- [Set Up Public Services on The Local Network by Virtual Servers](#)
- [Open Ports Dynamically by Port Triggering](#)
- [Make Applications Free from Port Restriction by DMZ](#)
- [Make Xbox Online Games Run Smoothly by UPnP](#)

12.1. ALG

ALG allows customized Network Address Translation (NAT) traversal filters to be plugged into the gateway to support address and port translation for certain application layer “control/data” protocols such as FTP, TFTP, H323 etc. It is recommended to keep the default settings.

You may need to disable SIP ALG when you are using voice and video applications to create and accept a call through the router, since some voice and video communication applications do not work well with SIP ALG.

Visit <http://tplinkmodem.net> or <http://192.168.1.1>, and log in with the password you set for the modem router. Go to **Advanced** > **Security** > **ALG**.

ALG	
PPTP Pass-through:	<input checked="" type="checkbox"/> Enable
L2TP Pass-through:	<input checked="" type="checkbox"/> Enable
IPSec Pass-through:	<input checked="" type="checkbox"/> Enable
FTP ALG:	<input checked="" type="checkbox"/> Enable
TFTP ALG:	<input checked="" type="checkbox"/> Enable
H323 ALG:	<input checked="" type="checkbox"/> Enable
RTSP ALG:	<input checked="" type="checkbox"/> Enable
SIP ALG:	<input checked="" type="checkbox"/> Enable

Save

12.2. Set Up Public Services on The Local Network by Virtual Servers

Virtual Servers are used to set up public services on the local network. A virtual server is defined as an external port, and all requests from the Internet to this external port will be redirected to a designated computer, which must be configured with a static or reserved IP address. When you build up a server on the local network and want to share it on the Internet, Virtual Servers can realize the service and provide it to the Internet users.

The table displays the relevant parameters of the virtual server.

To set up a Virtual Server rule:

1. Visit <http://tplinkmodem.net> or <http://192.168.1.1>, and log in with the password you set for the modem router.
2. Go to **Advanced** > **NAT Forwarding** > **Virtual Servers** and click  **Add**.
3. Select an interface name from the drop-down list.

Virtual Servers

+ Add - Delete

<input type="checkbox"/>	ID	Service Type	External Port	Internal IP	Internal Port	Protocol	Status	Modify
--	--	--	--	--	--	--	--	--

Note: Virtual Server can be configured only when there is an available interface. If the external port is already used for Remote Management or CWMP, Virtual Server will not take effect.

Interface Name:

Service Type: [View Existing Applications](#)

External Port: (XX-XX or XX)

Internal IP:

Internal Port: (XX or Blank, 1-65535)

Protocol:

Enable This Entry

[Cancel](#) [OK](#)

4. Click [View Existing Applications](#) to select a service from the list to automatically populate the appropriate port number in the [External Port](#) and [Internal Port](#) fields. If the service is not listed, enter the External Port number (e.g. 21) or a range of ports (e.g. 21-25). Leave the Internal Port blank if it is the same as the External Port or enter a specific port number (e.g. 21) if the External Port is a single port. The following picture takes application [FTP](#) as an example.

Virtual Servers

+ Add - Delete

<input type="checkbox"/>	ID	Service Type	External Port	Internal IP	Internal Port	Protocol	Status	Modify
--	--	--	--	--	--	--	--	--

Note: Virtual Server can be configured only when there is an available interface. If the external port is already used for Remote Management or CWMP, Virtual Server will not take effect.

Interface Name:

Service Type: [View Existing Applications](#)

External Port: (XX-XX or XX)

Internal IP:

Internal Port: (XX or Blank, 1-65535)

Protocol:

Enable This Entry

[Cancel](#) [OK](#)

5. Enter the IP address of the computer running the service application in the Internal IP field.
6. Select a protocol for the service application: TCP, UDP, or All from the Protocol dropdown list.
7. Select Enable This Entry.
8. Click **OK**.

 Tips:

- If you want to disable this entry, click the Bulb icon.
- It is recommended to keep the default settings of Internal Port and Protocol if you are not clear about which port or protocol to use.
- If the local host device is hosting more than one type of available services, you need to create a rule for each service. Please note that the External Port should NOT be overlapped.

12.3. Open Ports Dynamically by Port Triggering

Port Triggering can specify a triggering port and its corresponding external ports. When a host on the local network initiates a connection to the triggering port, all the external ports will be opened for subsequent connections. The router can record the IP address of the host. When the data from the internet return to the external ports, the router can forward them to the corresponding host. Port Triggering is mainly applied to online games, VoIPs, video players and common applications including MSN Gaming Zone, Dialpad and Quick Time 4 players, etc.

Follow the steps below to configure the Port Triggering rules:

1. Visit <http://tplinkmodem.net> or <http://192.168.1.1>, and log in with the password you set for the modem router.
2. Go to **Advanced > NAT Forwarding > Port Triggering** and click  **Add**.

Port Triggering

+ Add - Delete

<input type="checkbox"/>	ID	Application	Triggering Port	Triggering Protocol	External Port	External Protocol	Status	Modify
--	--	--	--	--	--	--	--	--

Interface Name:

Application: [View Existing Applications](#)

Triggering Port: (XX, 1-65535)

Triggering Protocol:

External Port: (XX or XX-XX, 1-65535, at most 5 pairs)

External Protocol:

Enable This Entry

[Cancel](#) [OK](#)

3. Click [View Existing Applications](#), and select the desired application. The [Triggering Port](#), [Triggering Protocol](#) and [External Port](#) will be automatically filled in. The following picture takes application [MSN Gaming Zone](#) as an example.

Port Triggering

+ Add - Delete

<input type="checkbox"/>	ID	Application	Triggering Port	Triggering Protocol	External Port	External Protocol	Status	Modify
--	--	--	--	--	--	--	--	--

Interface Name:

Application: [View Existing Applications](#)

Triggering Port: (XX, 1-65535)

Triggering Protocol:

External Port: (XX or XX-XX, 1-65535, at most 5 pairs)

External Protocol:

Enable This Entry

[Cancel](#) [OK](#)

4. Click [OK](#).

Port Triggering									
<input type="checkbox"/>	ID	Application	Triggering Port	Triggering Protocol	External Port	External Protocol	Status	Modify	
<input type="checkbox"/>	1	MSN Gaming Zone	47624	TCP or UDP	2300-2400, 28800-29000	TCP or UDP			

Tips:

- You can add multiple port triggering rules according to your network need.
- The triggering ports can not be overlapped.
- If the application you need is not listed in the Existing Applications list, please enter the parameters manually. You should verify the external ports the application uses first and enter them into **External Port** field according to the format the page displays.

12.4. Make Applications Free from Port Restriction by DMZ

When a PC is set to be a DMZ (Demilitarized Zone) host on the local network, it is totally exposed to the internet, which can realize the unlimited bidirectional communication between internal hosts and external hosts. The DMZ host becomes a virtual server with all ports opened. When you are not clear about which ports to open in some special applications, such as IP camera and database software, you can set the PC to be a DMZ host.

Note:

When DMZ is enabled, the DMZ host is totally exposed to the internet, which may bring some potential safety hazards. If DMZ is not in use, please disable it in time.

I want to:

Make the home PC join the internet online game without port restriction.

For example, due to some port restriction, when playing the online games, you can log in normally but cannot join a team with other players. To solve this problem, set your PC as a DMZ host with all ports open.

How can I do that?

1. Assign a static IP address to your PC, for example 192.168.1.100.
2. Visit <http://tplinkmodem.net> or <http://192.168.1.1>, and log in with the password you set for the modem router.
1. Go to **Advanced > NAT Forwarding > DMZ** and tick to enable DMZ.
3. Enter the PC's IP address 192.168.1.100 manually in the **DMZ Host IP Address** field.

DMZ

DMZ: Enable

DMZ Host IP Address:

2. Click **SAVE**.

Done!

The configuration is completed. You've set your PC to a DMZ host and now you can make a team to game with other players.

12.5. Make Xbox Online Games Run Smoothly by UPnP

The UPnP (Universal Plug and Play) protocol allows applications or host devices to automatically find the front-end NAT device and send request to it to open the corresponding ports. With UPnP enabled, the applications or host devices on the local network and the internet can freely communicate with each other thus realizing the seamless connection of the network. You may need to enable the UPnP if you want to use applications for multiplayer gaming, peer-to-peer connections, real-time communication (such as VoIP or telephone conference) or remote assistance, etc.

☞ Tips:

- UPnP is enabled by default in this router.
- Only the application supporting UPnP protocol can use this feature.
- UPnP feature needs the support of operating system (e.g. Windows Vista/ Windows 7/ Windows 8, etc. Some of operating system need to install the UPnP components).

For example, when you connect your Xbox to the router which has connected to the internet to play online games, UPnP will send request to the router to open the corresponding ports allowing the following data penetrating the NAT to transmit. Therefore, you can play Xbox online games without a hitch.

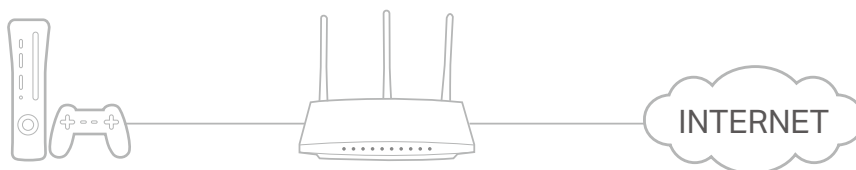

If necessary, you can follow the steps to change the status of UPnP.

1. Visit <http://tplinkmodem.net> or <http://192.168.1.1>, and log in with the password you set for the modem router.

2. Go to [Advanced](#) > [NAT Forwarding](#) > [UPnP](#) and toggle on or off according to your needs.

UPnP

UPnP:

UPnP Service List

Total Clients: 0 [Refresh](#)

ID	Service Description	External Port	Protocol	Internal IP Address	Internal Port
--	--	--	--	--	--

Chapter 13

Parental Controls

This function allows you to block inappropriate, explicit and malicious websites, and control access to specified websites at specified time.

I want to:

Control what types of websites my children or other home network users can visit and the time of day they are allowed to access the internet.

For example, I want to allow my children's devices (e.g. a computer or a tablet) to access only www.tp-link.com and Wikipedia.org from 18:00 (6 PM) to 22:00 (10 PM) on the weekdays and not other time.

How can I do that?

1. Visit <http://tplinkmodem.net> or <http://192.168.1.1>, and log in with the password you set for the modem router.
2. Go to **Basic > Parental Controls** or **Advanced > Parental Controls**.

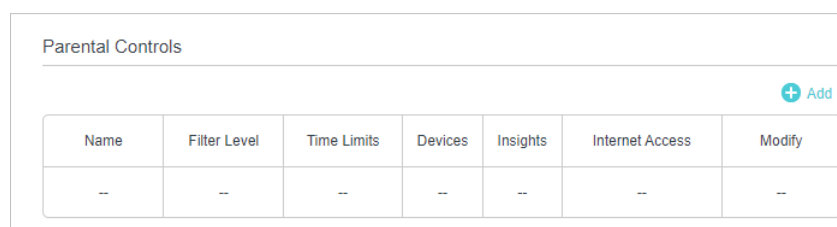

3. Click **Add**, and then enter the **Name** manually. Click **Add** and specify the devices belonging to the family member. Click **Next**.

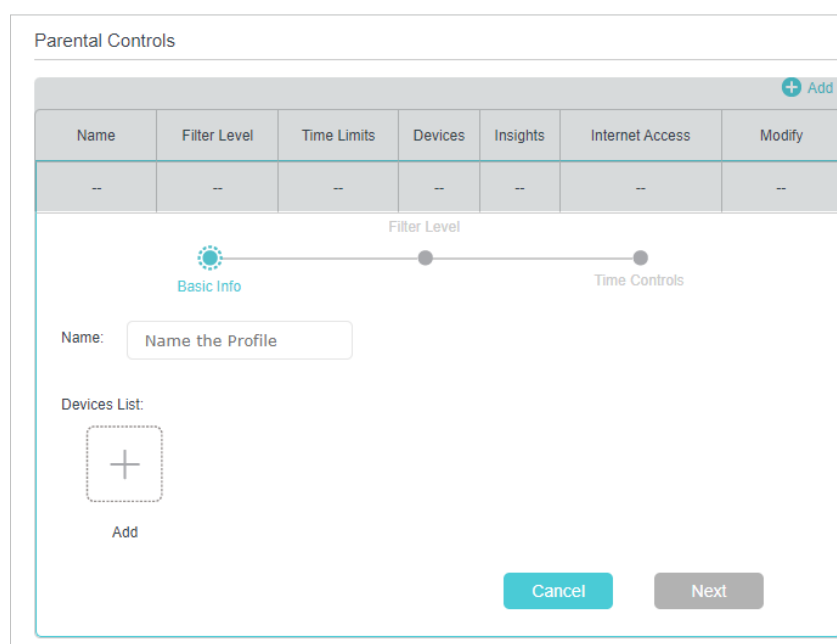

4. Select a filter level based on the age of the family member. Blocked content will then be displayed in the Filter Content list. Click **Next**.

Parental Controls

+ Add

Name	Filter Level	Time Limits	Devices	Insights	Internet Access	Modify
--	--	--	--	--	--	--

Filter Level

Basic Info Time Controls



Child
(0-7)



Pre-Teen
(8-12)



Teen
(13-17)



Adult
(>17)

Based on the selected filter level, Adult Content, Social Networking have already been filtered for 123. You can block more from Available Categories or by adding a new keyword.

Filter Content + Add a New Keyword Available Categories:

<p>Adult Content</p> <p>Social Networking -</p>	<p>Games +</p> <p>Media +</p> <p>Online Communication +</p> <p>Pay to Surf +</p> <p>Downloads +</p>
--	--

Cancel
Back
Next

5. (Optional) Delete items from the Filter Content list, add items from the Available Categories list, or click Add a New Keyword to add a filter keyword (for example, "Facebook") or URL.
6. Enable Time Limits for Mon to Fri and Sat & Sun, then set the daily internet time allowed. Enable BedTime on School Nights (Sunday to Thursday) and Weekend (Friday and Saturday), then set the time period during devices in the profile cannot access the internet.

Parental Controls

+ Add

Name	Filter Level	Time Limits	Devices	Insights	Internet Access	Modify
--	--	--	--	--	--	--

Filter Level

Basic Info Time Controls

Weekdays Mon Tues Wed Thur Fri Sat Sun

Time Limits
Set daily time limits for the total time spent online.

Weekdays Enable 2h

Weekends Enable 2h

Bed Time
Set a time period while this profile cannot access the internet.

Weekdays Enable From 10 : 00 PM To 06 : 00 AM

Weekends Enable From 10 : 00 PM To 06 : 00 AM

7. Click [Save](#).



Done!

Now you can control your children's internet access as needed.

Tips:

- To monitor internet usage of a family member:
 1. Find the profile of the family member, then click the **Insights** icon.
 2. On the **Top 5 Visits** page, select a day of the last 7 days to check the time spent online and top visited websites. You can block the websites if needed.
 3. On the **Blocked History** page, select a day of the last 7 days to check the blocked website history. You can **unblock websites** if needed, and click Unblocked Websites to view them.

Parental Controls

Name	Filter Level	Time Limits	Devices	Insights	Internet Access	Modify
123	Pre-Teen	2h	1			



Top 5 Visits Blocked History

Today



- To pause or resume internet access of a family member:
Find the profile of the family member, then click the **Pause/Play** icon.

Parental Controls

Name	Filter Level	Time Limits	Devices	Insights	Internet Access	Modify
123	Pre-Teen	2h	1		 Paused	

Chapter 14

Quality of Service

This function allows you to specify the priority of traffic and minimizes the impact of network congestion.

The modem router allows you to configure the quality of service (QoS) for optimal throughput and performance when handling differentiated wireless traffic, such as Voiceover-IP (VoIP), other types of audio, video, streaming media, and traditional IP data. To configure QoS on the modem routers, you should set parameters on the transmission queues for different types of wireless traffic. In normal use, we recommend that you keep the default values for the modem routers.

14. 1. Set up QoS for the network

This feature helps the modem router allocate upstream bandwidth to improve the network's overall performance.

To set up QoS for the network:

1. Visit <http://tplinkmodem.net> or <http://192.168.1.1>, and log in with the password you set for the modem router.
2. Go to [Advanced](#) > [QoS](#) > [Basic Settings](#).
3. Enable [QoS](#).

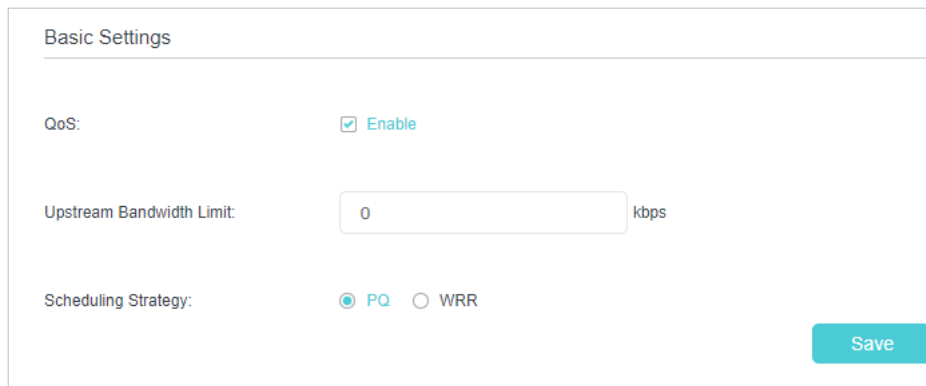

The screenshot shows the 'Basic Settings' page for QoS configuration. It includes the following fields and options:

- QoS:** A checkbox labeled 'Enable' is checked.
- Upstream Bandwidth Limit:** A text input field containing the value '0', followed by the unit 'kbps'.
- Scheduling Strategy:** Two radio buttons are present: 'PQ' (selected) and 'WRR'.
- Save:** A blue button labeled 'Save' is located at the bottom right of the form.

4. Select the scheduling algorithm according to your needs.
 - **PQ (Priority Queue):** Select this if you want to ensure services in higher-priority queues. The router will process outgoing traffic from the highest-priority queue first, then from a lower-priority queue.
 - **WRR (Weighted Round Robin):** Select this if you want to balance traffic in queues proportional to their queue weight. The router will process more packets in a queue if the queue has a higher weight.
5. Enter your total [Upstream Bandwidth Limit](#).
6. Click [Save](#) to make the settings effective.

14.2. Configure Queue Settings

This page allows you to manage your network with queues. With SP algorithm, you can define packets which is more important and get through more quickly; with WRR algorithm, you can allocate quota of bandwidth to certain kind of packets.

1. Visit <http://tplinkmodem.net> or <http://192.168.1.1>, and log in with the password you set for the modem router.
2. Go to [Advanced](#) > [QoS](#) > [Queue Settings](#).

With PQ algorithm:

Queue Settings

Queue Class	Priority	Enable
1	Highest	<input checked="" type="checkbox"/> Yes
2	High	<input checked="" type="checkbox"/> Yes
3	Middle	<input checked="" type="checkbox"/> Yes
4	Low	<input checked="" type="checkbox"/> Yes

With WRR algorithm:

Queue Settings

Queue Class	Weight	Enable
1	<input style="width: 80%;" type="text" value="0"/>	<input checked="" type="checkbox"/> Yes
2	<input style="width: 80%;" type="text" value="0"/>	<input checked="" type="checkbox"/> Yes
3	<input style="width: 80%;" type="text" value="0"/>	<input checked="" type="checkbox"/> Yes
4	<input style="width: 80%;" type="text" value="0"/>	<input checked="" type="checkbox"/> Yes

3. In the [Queue Settings](#) table, choose a priority section and click [Save](#).

14.3. Configure Flow Classification

This page allows you to add classification rules to choose certain kind of packages to enter a queue. The classification of packages is based mainly on the differences of data link layer header, network layer header, transport layer header and so on. An option should be empty if you don't want to use it for a classification.

1. Visit <http://tplinkmodem.net> or <http://192.168.1.1>, and log in with the password you set for the modem router.
2. Go to [Advanced](#) > [QoS](#) > [Flow Classification](#)
3. Click [Add](#) to enter new information and configure more settings.

Flow Classification

+ Add - Delete

<input type="checkbox"/>	Classification Name	Classification Criteria	Queue belong	Status	Delete
--	--	--	--	--	--

Class Name:

Enable

Specify Classification Criteria(A blank criteria indicates it is not used for classification.)

Ingress Interface:

Source MAC Address:

Destination MAC Address:

802.1P Priority Check:

Source IP Address Min:

Source IP Address Max:

Destination IP Address Min:

Destination IP Address Max:

DSCP Check:

Protocol:

Source Port Range: --

Destination Port Range: --

Specify Classification Results(A blank criteria indicates no operation.)

Queue:

Mark DSCP:

Mark 802.1P Priority:

Class Name: Each classification has a unique name as its identification.

Ingress interface: Classification will only take effect at packets ingressing from this interface.

Source MAC Address: Source mac address for classification.

Destination MAC Address: Destination mac address for classification. Please note that only LAN mac address can take effect.

Source IP Address Min/Max: Source ip address for classification.

Destination IP Address Min/Max: Destination ip address for classification.

DSCP Check: Classification will only take effect at packets having this DSCP.

Protocol: Classification will only take effect at packets of this protocol.

Queue: Packets matching the classification will enter this queue.

Mark DSCP: Packets matching the classification will be marked at DSCP field.

Mark 802.1P Priority: Packets matching the classification will be marked at 802.1P field.

Note: If you want to delete a classification, select the corresponding checkbox of the rules to be deleted in the classification list, and click [Delete](#) above the table to delete selected classifications, or click [Delete](#) icon to delete one classification.

Chapter 15

Network Security

This chapter guides you on how to protect your home network from unauthorized users by implementing network security functions. You can block or allow specific client devices to access your wireless network using MAC Filtering, or using Access Control for wired and wireless networks, or you can prevent ARP spoofing and ARP attacks by using IP & MAC Binding.

This chapter contains the following sections:

- [Firewall & DoS Protection](#)
- [Service Filtering](#)
- [Access Control](#)
- [IP & MAC Binding](#)
- [IPv6 Firewall](#)

15.1. Firewall & DoS Protection

The SPI (Stateful Packet Inspection) Firewall and DoS (Denial of Service) Protection protect the router from cyber attacks.

The SPI Firewall can prevent cyber attacks and validate the traffic that is passing through the router based on the protocol. This function is enabled by default, and it is recommended to keep the default settings.

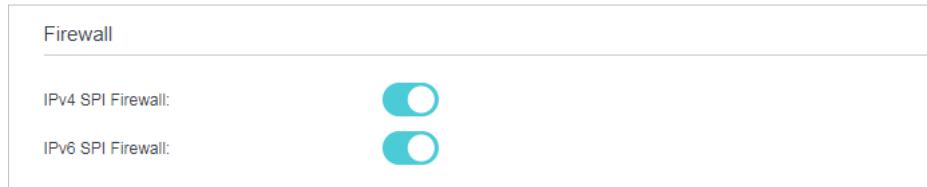

DoS Protection can protect your home network against DoS attacks from flooding your network with server requests. Follow the steps below to configure DoS Protection.

1. Visit <http://tplinkmodem.net> or <http://192.168.1.1>, and log in with the password you set for the modem router.
2. Go to **Advanced > Security > Firewall & DoS Protection**.

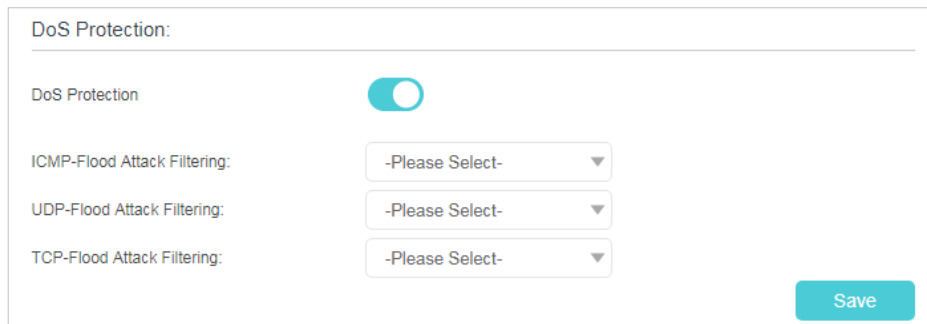

3. Enable **DoS Protection**.
4. Set the protection level (**Low**, **Middle** or **High**) for **ICMP-Flood Attack Filtering**, **UDP-Flood Attack Filtering** and **TCP-Flood Attack Filtering**.
 - **ICMP-Flood Attack Filtering** - Enable to prevent the ICMP (Internet Control Message Protocol) flood attack.
 - **UDP-Flood Attack Filtering** - Enable to prevent the UDP (User Datagram Protocol) flood attack.
 - **TCP-Flood Attack Filtering** - Enable to prevent the TCP (Transmission Control Protocol) flood attack.
5. Click **Save**.

 **Tips:**

1. The level of protection is based on the number of traffic packets. You can specify the level under **DoS Protection Level Settings**.

Dos Protection Level Settings

ICMP-Flood Protection Level:	Low:	1200	(5-3600) packets/sec
	Middle:	2400	(5-3600) packets/sec
	High:	3600	(5-3600) packets/sec
UDP-Flood Protection Level:	Low:	1200	(5-3600) packets/sec
	Middle:	2400	(5-3600) packets/sec
	High:	3600	(5-3600) packets/sec
TCP-SYN-Flood Protection Level:	Low:	1200	(5-3600) packets/sec
	Middle:	2400	(5-3600) packets/sec
	High:	3600	(5-3600) packets/sec

Save

- The protection will be triggered immediately when the number of packets exceeds the preset threshold value, and the vicious host will be displayed in the [Blocked DoS Host List](#).

Blocked DoS Host List

Host Number: 0 [Refresh](#) [Delete](#)

<input type="checkbox"/>	ID	IP Address	MAC Address
--	--	--	--

15.2. Service Filtering

With Service Filtering, you can prevent certain users from accessing the specified service, and even block internet access completely.

- Visit <http://tplinkmodem.net> or <http://192.168.1.1>, and log in with the password you set for the modem router.
- Go to [Advanced](#) > [Security](#) > [Service Filtering](#), and enable [Service Filtering](#).

Service Filtering

Service Filtering:

- Click [Add](#).

Filtering List

Refresh + Add - Delete

<input type="checkbox"/>	ID	Service Type	Port	IP Address	Status	Modify
--	--	--	--	--	--	--

Service Type:

Protocol:

Starting Port: (1-65535)

Ending Port: (1-65535)

Service Type:

Filter Service For: Single IP Address IP Address Range All IP Addresses

4. Select a **Service Type** from the drop-down list and the following four fields will be automatically filled in. Select **Custom** when your desired service type is not listed, and enter the information manually.
5. Specify the IP address(es) that this filtering rule will apply to.
6. Click **Save** to make the settings effective.

■ Note: If you want to disable an entry, click the  icon.

15.3. Access Control

Access Control is used to block or allow specific client devices to access your network (via wired or wireless) based on a list of blocked devices (Blacklist) or a list of allowed devices (Whitelist).

I want to: Block or allow specific client devices to access my network (via wired or wireless).

How can I do that?

1. Visit <http://tplinkmodem.net> or <http://192.168.1.1>, and log in with the password you set for the modem router.
2. Go to **Advanced > Security > Access Control** and enable **Access Control**.

Access Control

Access Control:

3. Select the access mode to either block (recommended) or allow the device(s) to access your network.

To block specific device(s):

- 1) Select **Blacklist** and click **Save**.

Access Mode

Access Mode:

Blacklist

Whitelist

[Save](#)

- 2) Select the device(s) to be blocked in the **Online Devices** table (or click the **Add** under the **Devices in Blacklist** and enter the **Device Name** and **MAC Address** manually).

- 3) Click **Block** above the **Online Devices** table. The selected devices will be added to **Devices in Blacklist** automatically.

Devices in Blacklist

[+ Add](#) [- Delete](#)

	ID	Device Name	MAC Address	Modify
<input type="checkbox"/>	--	--	--	--

Device Name: [Scan](#)

MAC Address: [Cancel](#) [OK](#)

Online Devices

[Refresh](#) [Block](#)

	ID	Device Name	IP Address	MAC Address	Connection Type
<input type="checkbox"/>	1	Unknown	192.168.1.218	[MAC Address]	Wired

To allow specific device(s):

- 1) Select **Whitelist** and click **Save**.

Access Mode

Access Mode:

Blacklist

Whitelist

[Save](#)

- 2) Click **Add** in the **Devices in Whitelist** section.

The screenshot shows a web interface titled "Devices in Whitelist". At the top right, there are two buttons: a green "+ Add" button and a red "- Delete" button. Below this is a table with the following columns: a checkbox, "ID", "Device Name", "MAC Address", and "Modify". The table currently contains one row with dashes in all cells. Below the table, there are two input fields: "Device Name:" followed by a text box, and "MAC Address:" followed by a text box with a dashed pattern. At the bottom right, there are two buttons: a teal "Cancel" button and a teal "Save" button.

- 3) Enter the [Device Name](#) and [MAC Address](#). (You can copy and paste the information from [Online Devices](#) table if the device is connected to your network.)
- 4) Click [Save](#).

Done!

Now you can block or allow specific client devices to access your network (via wired or wireless) by [Blacklist](#) or [Whitelist](#).

15.4. IP & MAC Binding

IP & MAC Binding, namely, ARP (Address Resolution Protocol) Binding, is used to bind a network device's IP address to its MAC address. This will prevent ARP spoofing and other ARP attacks by denying network access to a device with a matching IP address in the Binding list, but an unrecognized MAC address.

I want to:

Prevent ARP spoofing and ARP attacks.

How can I do that?

1. Visit <http://tplinkmodem.net> or <http://192.168.1.1>, and log in with the password you set for the modem router.
2. Go to [Advanced](#) > [Security](#) > [IP & MAC Binding](#), and enable [IP & MAC Binding](#).

IP & MAC Binding

IP & MAC Binding:

Binding List

+ Add - Delete

<input type="checkbox"/>	ID	MAC Address	IP Address	Status	Enable	Modify
<input type="checkbox"/>	--	--	--	--	--	--

ARP List

Refresh Bind

<input type="checkbox"/>	ID	Device Name	MAC Address	IP Address	Bound	Modify
<input type="checkbox"/>	1	Unknown	FC:34:97:BC:F5:87	192.168.1.218	Unloaded	

3. Bind your device(s) according to your needs.

To bind the connected device(s):

- 1) Select the device(s) to be bound in the [ARP List](#).
- 2) Click [Bind](#) to add to the [Binding List](#).

To bind the unconnected device:

- 1) Click [Add](#) in the [Binding List](#) section.

Binding List

+ Add - Delete

<input type="checkbox"/>	ID	MAC Address	IP Address	Status	Enable	Modify
<input type="checkbox"/>	--	--	--	--	--	--

MAC Address:

IP Address:

[Enable This Entry](#)

[Cancel](#) [OK](#)

- 2) Enter the [MAC address](#) and [IP address](#) that you want to bind.
- 3) Select the [Enable This Entry](#) check box to enable the entry and click [Save](#).

Done!

Enjoy the internet without worrying about ARP spoofing and ARP attacks.

15.5. IPv6 Firewall

IPv6 Firewall protects your IPv6 network by preventing access from the internet. However, when you are hosting a service, such as a file sharing server in your local network, you can choose to allow access to the server from the internet by adding entries on this page. This feature is available only when you've set up an IPv6 connection.

1. Visit <http://tplinkmodem.net> or <http://192.168.1.1>, and log in with the password you set for the modem router.
2. Go to [Advanced](#) > [Security](#) > [IPv6 Firewall](#).

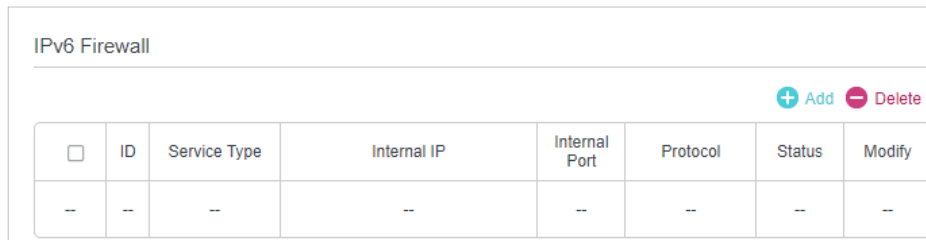

IPv6 Firewall

+ Add - Delete

<input type="checkbox"/>	ID	Service Type	Internal IP	Internal Port	Protocol	Status	Modify
<input type="checkbox"/>	--	--	--	--	--	--	--

3. Click [Add](#).

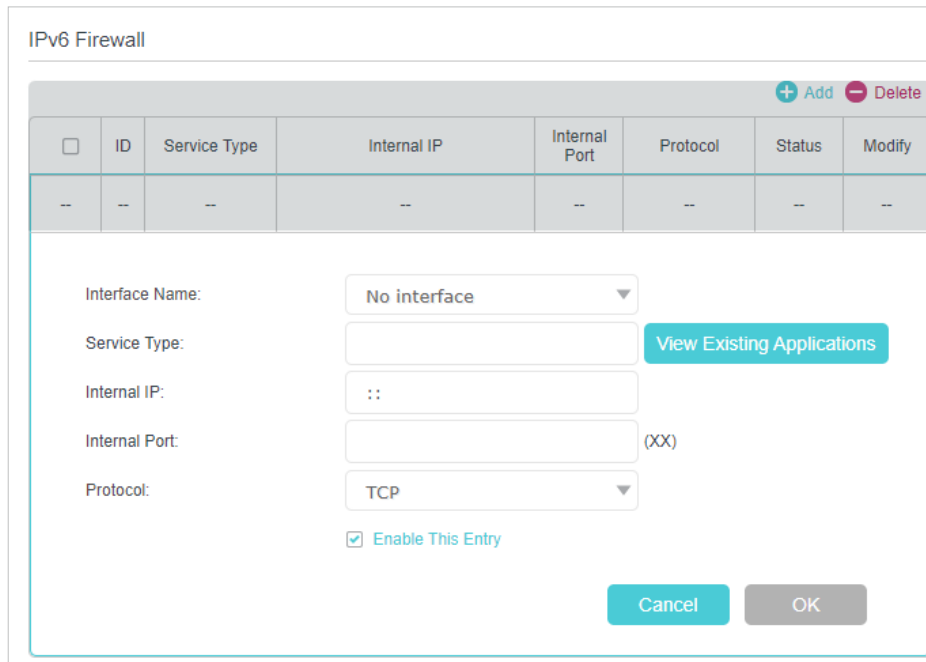

IPv6 Firewall

+ Add - Delete

<input type="checkbox"/>	ID	Service Type	Internal IP	Internal Port	Protocol	Status	Modify
<input type="checkbox"/>	--	--	--	--	--	--	--

Interface Name:

Service Type: [View Existing Applications](#)

Internal IP:

Internal Port: (XX)

Protocol:

Enable This Entry

[Cancel](#) [OK](#)

4. Select an interface name from the drop-down list. Interface names are names of the internet connections you have set up.
5. Click [View Existing Applications](#) to select a service from the list to automatically populate the Port field with an appropriate port number. It is recommended to keep the default Port if you are unsure about which one to use. If the service is not listed, manually enter the Service Type and the Port number (e.g., 21 or 21-25). The following picture takes application [FTP](#) as an example.

IPv6 Firewall

+ Add - Delete

<input type="checkbox"/>	ID	Service Type	Internal IP	Internal Port	Protocol	Status	Modify
--	--	--	--	--	--	--	--

Interface Name:

Service Type: [View Existing Applications](#)

Internal IP:

Internal Port: (XX)

Protocol:

Enable This Entry

[Cancel](#) [OK](#)

6. Select the local host device running the service. Enter its global IPv6 address in the Global IPv6 Address field.
7. Select a protocol for the service from the drop-down list.
8. Select Enable This Entry.
9. Click OK.

 Tips:

- If you want to disable this entry, click the Bulb icon.
- If the local host device hosts more than one type of available service, you need to create a rule for each service. Please note that ports should NOT be used by multiple services.

Chapter 16

VPN Server&Client

The router offers several ways to set up VPN connections:

VPN Server allows remote devices to access your home network in a secured way through the internet. The router supports three types of VPN Server:

OpenVPN is somewhat complex but with higher security and more stability, suitable for restricted environments such as campus network and company intranet.

PPTP VPN is easy to use with the built-in VPN software of computers and mobile devices, but it is vulnerable and may be blocked by some ISPs.

L2TP/IPSec VPN is more secure but slower than PPTP VPN, and may have trouble getting around firewalls.

VPN Client allows devices in your home network to access remote VPN servers, without the need to install VPN software on each device.

This chapter contains the following sections:

- [Use OpenVPN to Access Your Home Network](#)
- [Use PPTP VPN to Access Your Home Network](#)
- [Use IPSec VPN to Access Your Home Network](#)
- [VPN Connections](#)

16.1. Use OpenVPN to Access Your Home Network

OpenVPN Server is used to create an OpenVPN connection for remote devices to access your home network.

To use the VPN feature, you need to enable OpenVPN Server on your router, and install and run VPN client software on remote devices. Please follow the steps below to set up an OpenVPN connection.

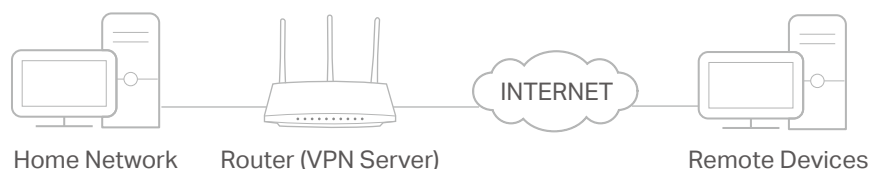

Step1. Set up OpenVPN Server on Your Router

1. Visit <http://tplinkmodem.net> or <http://192.168.1.1>, and log in with the password you set for the modem router.
2. Go to **Advanced > VPN > OpenVPN**, and tick the box of **Enable VPN Server**.

OpenVPN

Note: No certificate currently, please **Generate** one before enabling VPN Server.

Enable VPN Server

Service Type: UDP TCP

Service Port:

VPN Subnet/Netmask:

Client Access: Home Network Only Internet and Home Network

Save

Note:

- Before you enable VPN Server, we recommend you configure Dynamic DNS Service (recommended) or assign a static IP address for router's WAN port and synchronize your System Time with internet.
- The first time you configure the OpenVPN Server, you may need to generate a certificate before you enable the VPN Server.

3. Select the **Service Type** (communication protocol) for OpenVPN Server: UDP, TCP.
4. Enter a VPN **Service Port** to which a VPN device connects, and the port number should be between 1024 and 65535.
5. In the **VPN Subnet/Netmask** fields, enter the range of IP addresses that can be leased to the device by the OpenVPN server.
6. Select your **Client Access** type. Select **Home Network Only** if you only want the remote device to access your home network; select **Internet and Home Network** if you also want the remote device to access internet through the VPN Server.

7. Click **SAVE**.
8. Click **GENERATE** to get a new certificate.

Certificate

Generate the certificate.

GENERATE

Note: If you have already generated one, please skip this step, or click **GENERATE** to update the certificate.

9. Click **EXPORT** to save the OpenVPN configuration file which will be used by the remote device to access your router.

Configuration File

Export the configuration file.

EXPORT

Step 2. Configure OpenVPN Connection on Your Remote Device

1. Visit <http://openvpn.net/index.php/download/community-downloads.html> to download the OpenVPN software, and install it on your device where you want to run the OpenVPN client utility.

Note: You need to install the **OpenVPN** client utility on each device that you plan to apply the VPN function to access your router. Mobile devices should download a third-party app from Google Play or Apple App Store.

2. After the installation, copy the file exported from your router to the OpenVPN client utility's "config" folder (for example, `C:\Program Files\OpenVPN\config` on Windows). The path depends on where the OpenVPN client utility is installed.
3. Run the OpenVPN client utility and connect it to OpenVPN Server.

16.2. Use PPTP VPN to Access Your Home Network

PPTP VPN Server is used to create a PPTP VPN connection for remote devices to access your home network.

To use the VPN feature, you need to set up PPTP VPN Server on your router, and configure the PPTP connection on remote devices. Please follow the steps below to set up a PPTP VPN connection.

Step 1. Set up PPTP VPN Server on Your Router

1. Visit <http://tplinkmodem.net> or <http://192.168.1.1>, and log in with the password you set for the modem router.
2. Go to **Advanced > VPN > PPTP VPN**, and tick the box of **Enable VPN Server**.

PPTP VPN

Enable VPN Server

Client IP Address: 10 . 7 . 0 . 11 -10.7.0. 20 (up to 10 clients)

Username:

Password: 

Save

Note: Before you enable [VPN Server](#), we recommend you configure Dynamic DNS Service (recommended) or assign a static IP address for router's WAN port and synchronize your [System Time](#) with internet.

3. In the [Client IP Address](#) field, enter the range of IP addresses (up to 10) that can be leased to the devices by the PPTP VPN server.
4. Enter the [Username](#) and [Password](#) to authenticate clients to the PPTP VPN server.
5. Click [SAVE](#).
6. On the client devices, create a PPTP VPN connection. The official supported platforms include Windows, Mac OSX, Linux, iOS, and Android.
7. Launch the PPTP VPN program, add a new connection and enter the domain name of the registered DDNS service or the static IP address that is assigned to the WAN port, to connect the client device to the PPTP VPN server.

Step 2. Configure PPTP VPN Connection on Your Remote Device

The remote device can use the Windows built-in PPTP software or a third-party PPTP software to connect to PPTP Server. Here we use the [Windows built-in PPTP software](#) as an example.

1. Go to [Start > Control Panel > Network and Internet > Network and Sharing Center](#).
2. Select [Set up a new connection or network](#).

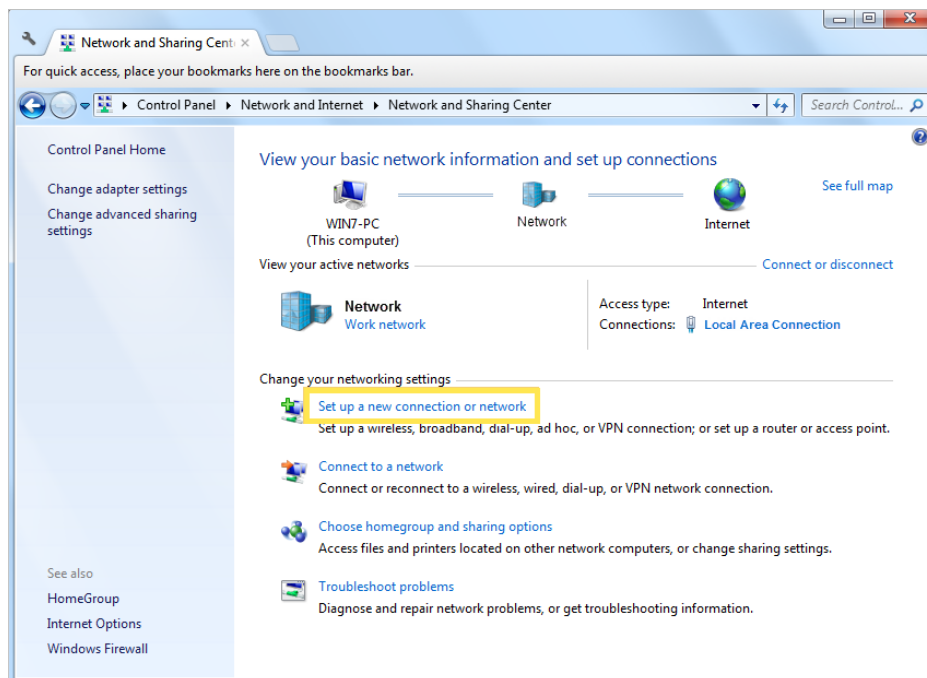

3. Select [Connect to a workplace](#) and click [Next](#).

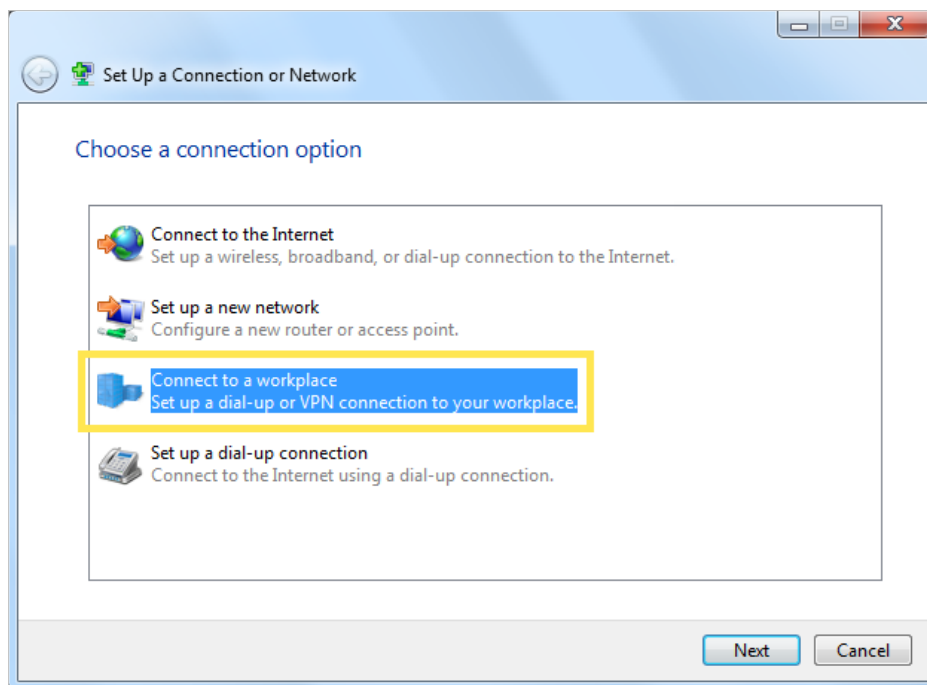

4. Select [Use my Internet connection \(VPN\)](#).

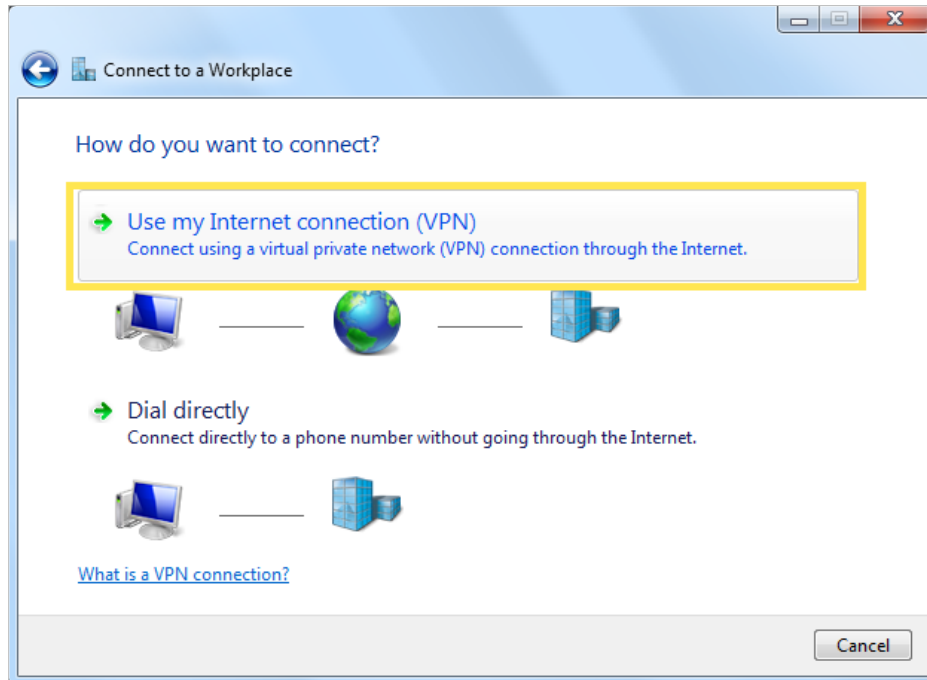

5. Enter the internet IP address of the router (for example: 218.18.1.73) in the **Internet address** field. Click **Next**.

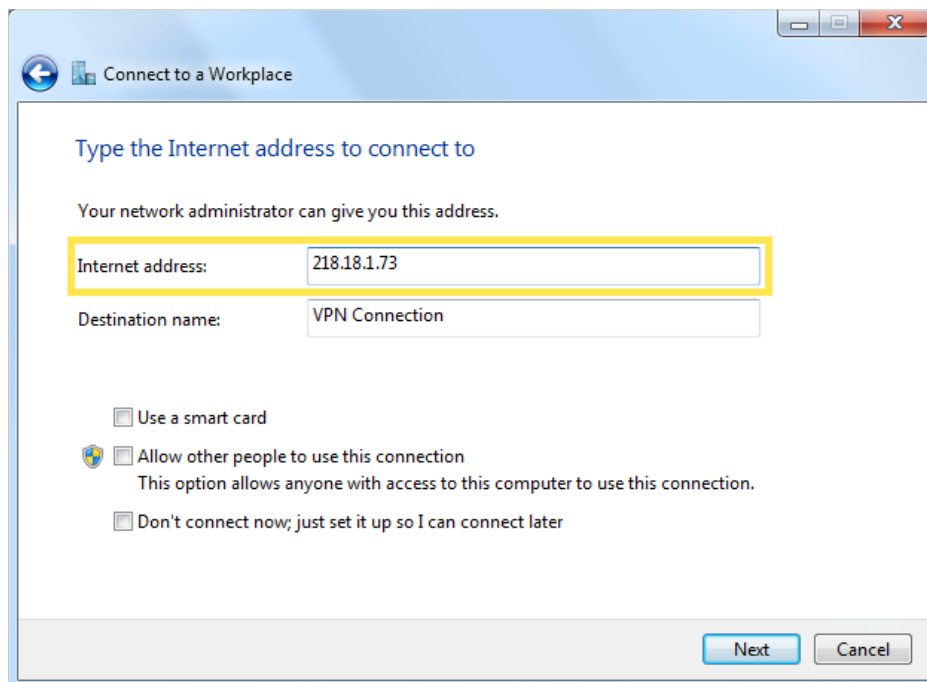

6. Enter the **User name** and **Password** you have set for the PPTP VPN server on your router, and click **Connect**.

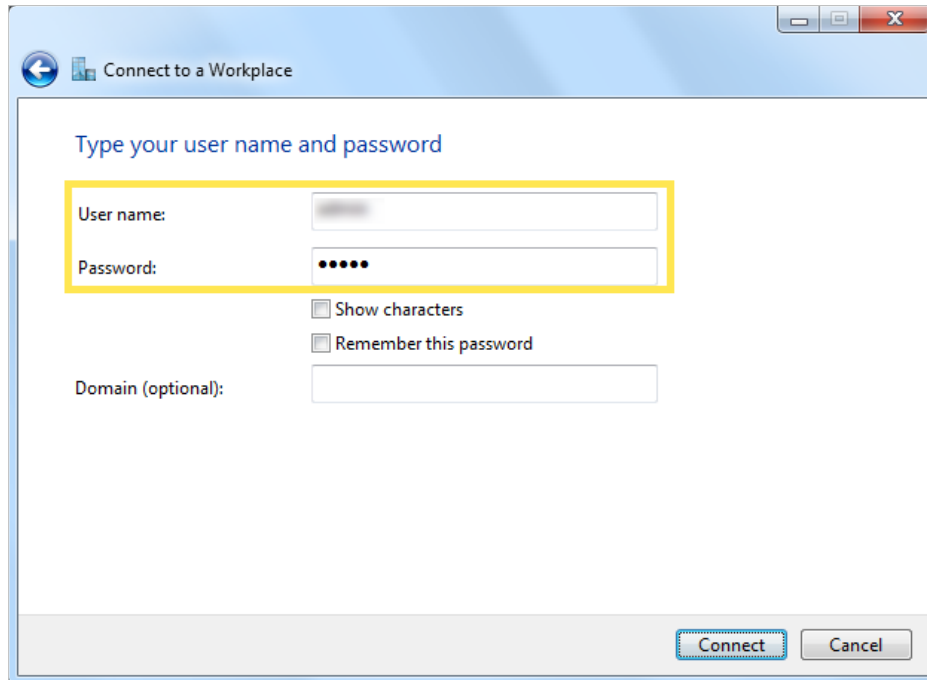

7. Click [Connect Now](#) when the VPN connection is ready to use.

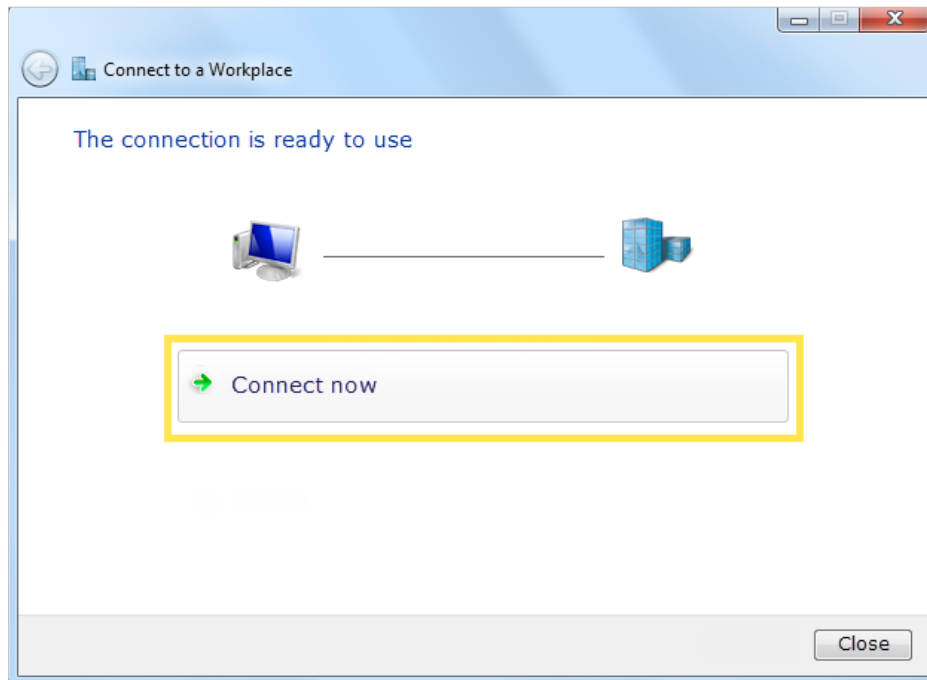

16.3. Use IPSec VPN to Access Your Home Network

IPSec VPN Server is used to create a IPSec VPN connection for remote devices to access your home network.

To use the VPN feature, you need to set up IPsec VPN Server on your router, and configure the IPsec connection on remote devices. Please follow the steps below to set up the IPsec VPN connection.

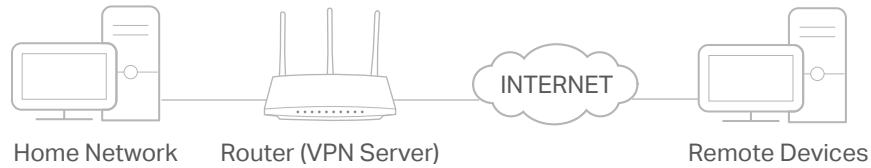

Step 1. Set up IPsec VPN Server on Your Router

1. Visit <http://tplinkmodem.net> or <http://192.168.1.1>, and log in with the password you set for the modem router.
2. Go to **Advanced > VPN > IPsec VPN**, and enable **Dead Peer Detection**.

Note:

- Firmware update may be required to support IPsec VPN Server.
- Before you enable **Dead Peer Detection**, we recommend you configure Dynamic DNS Service (recommended) or assign a static IP address for router's WAN port and synchronize your **System Time** with internet.

IPsec VPN

Dead Peer Detection:

[+ Add](#) [- Delete](#)

<input type="checkbox"/>	Connection Name	Remote Gateway	Local Address	Remote Address	Status	Enable	Modify
--	--	--	--	--	--	--	--

3. Click **Add**.
4. Configure the IPsec VPN server parameters.

Dead Peer Detection:

+ Add - Delete

<input type="checkbox"/>	Connection Name	Remote Gateway	Local Address	Remote Address	Status	Enable	Modify
--	--	--	--	--	--	--	--

IPSec Connection Name:

Remote IPSec Gateway (URL):

Tunnel access from local IP addresses:

IP Address for VPN:

Subnet Mask:

Tunnel access from remote IP addresses:

IP Address for VPN:

Subnet Mask:

Key Exchange Method:

Authentication Method:

Pre-Shared Key:

Perfect Forward Secrecy:

Advanced

5. Configure the advanced settings according to the following explanation. We recommend that you keep the default settings. If you want to change these settings, make sure that both VPN server endpoints use the same Encryption Algorithm, Integrity Algorithm, Diffie-Hellman Group and Key Lifetime in both phase1 and phase2.

Advanced

==Phase 1==

Mode: Main

Local Identifier Type: Local Wan IP

Local Identifier:

Remote Identifier Type: Remote Wan IP

Remote Identifier:

Encryption Algorithm: 3DES

Integrity Algorithm: MD5

Diffie-Hellman Group for Key Exchange: 1024bit

Key Life Time(Seconds): 3600

==Phase 2==

Encryption Algorithm: 3DES

Integrity Algorithm: MD5

Diffie-Hellman Group for Key Exchange: 1024bit

Key Life Time(Seconds): 3600

Cancel OK

6. Click **OK**.

Note:

- For the comprehensive guide, please refer to the User Guide on the product's support page.

Step 2. Configure IPSec VPN Connection on Your Remote Device

The remote device can use the Windows or Mac OS built-in IPSec software or a third-party IPSec software to connect to IPSec Server. Here we use the [Windows built-in IPSec software](#) as an example.

1. Go to [Start > Control Panel > Network and Internet > Network and Sharing Center](#).
2. Select [Set up a new connection or network](#).

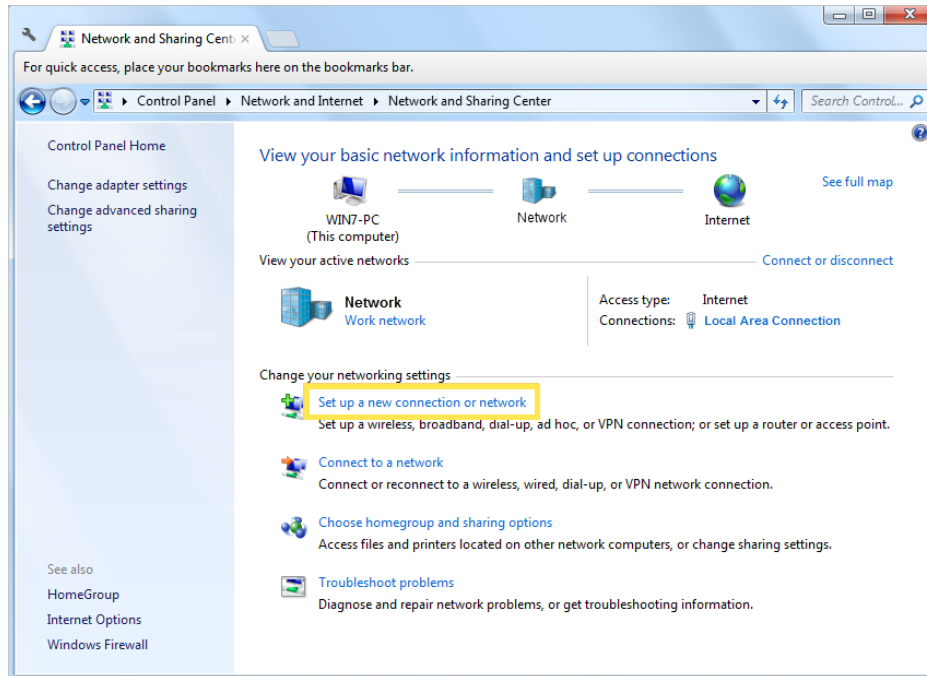

3. Select [Connect to a workplace](#) and click [Next](#).

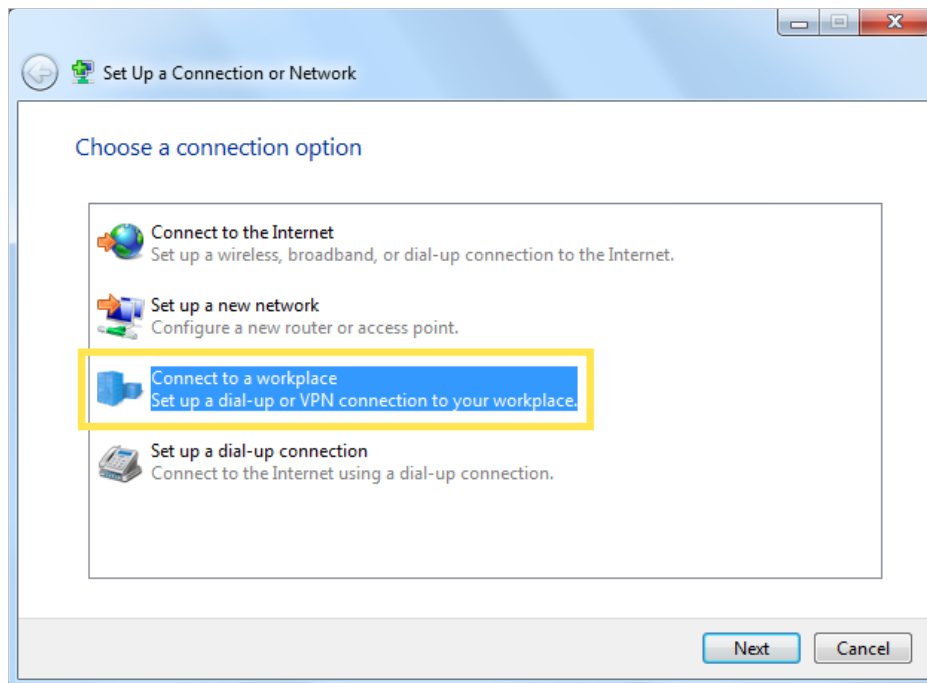

4. Select [Use my Internet connection \(VPN\)](#).

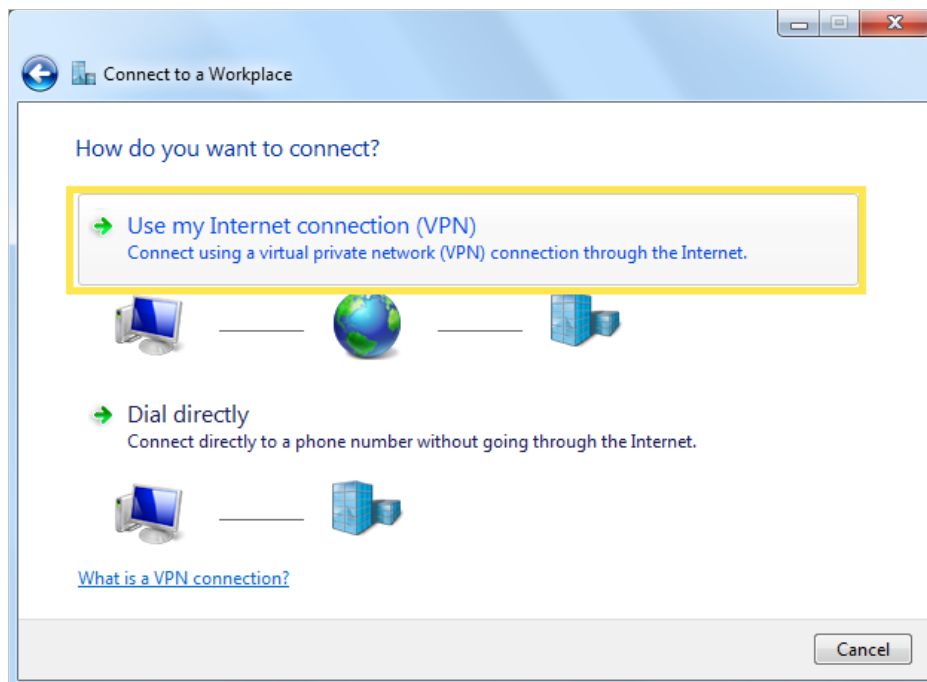

5. Enter the internet IP address of the router (for example: 218.18.1.73) in the **Internet address** field, and select the checkbox **Don't connect now; just set it up so I can connect later**. Click **Next**.

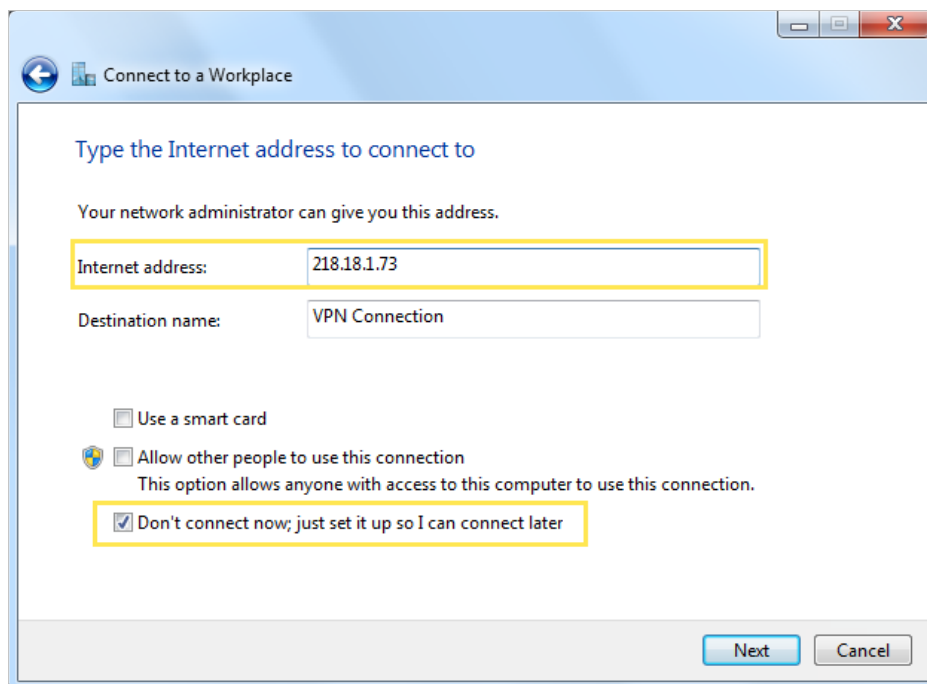

6. Enter the **User name** and **Password** you have set for the IPSec VPN server on your router, and click **Connect**.

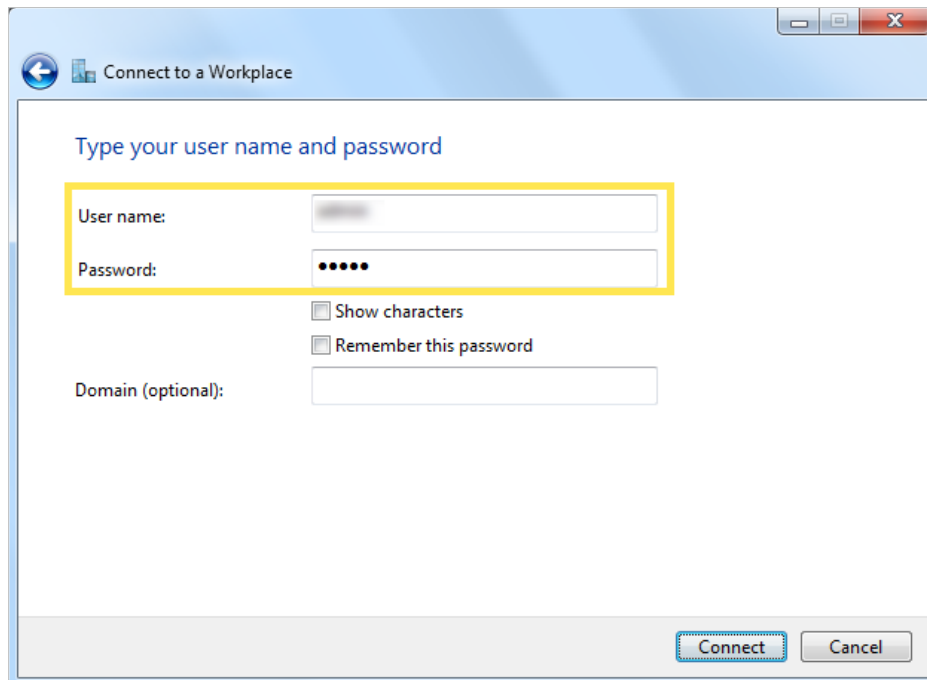

7. Click **Close** when the VPN connection is ready to use

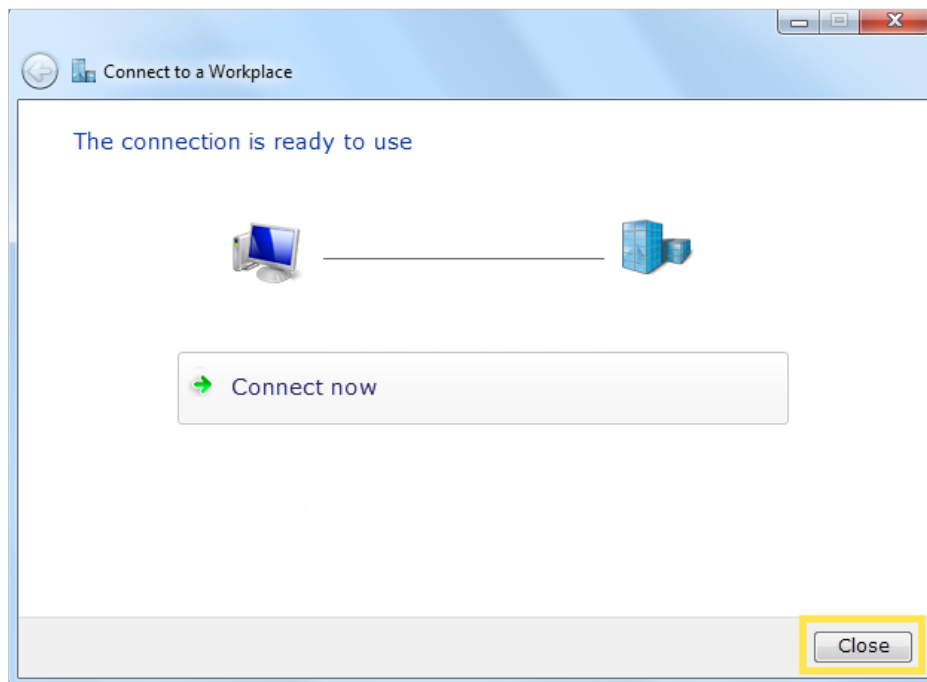

8. Go to **Network and Sharing Center** and click **Change adapter settings**.

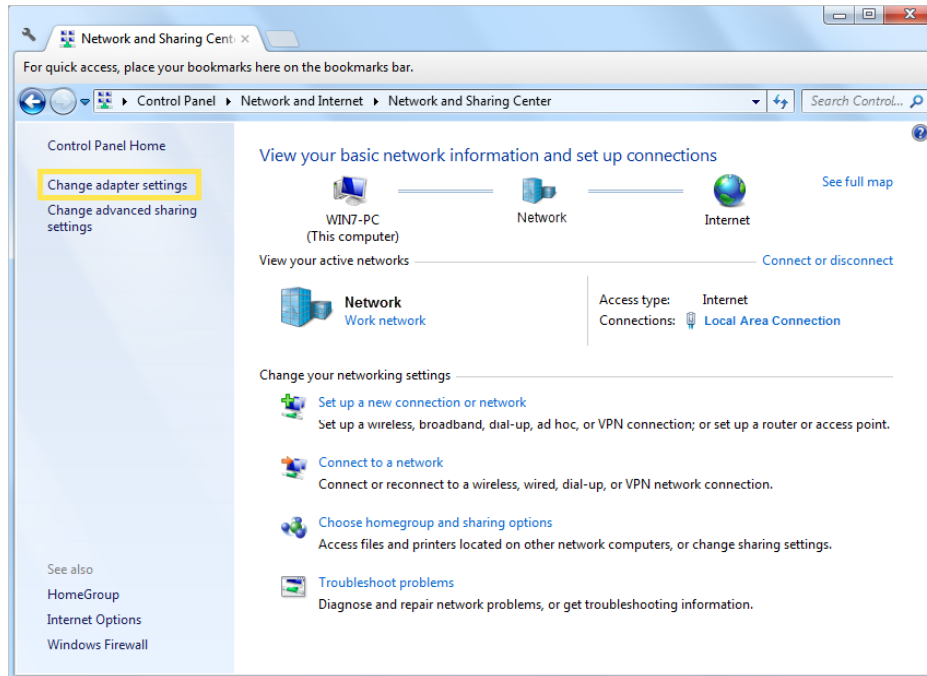

9. Find the VPN connection you created, then double-click it.

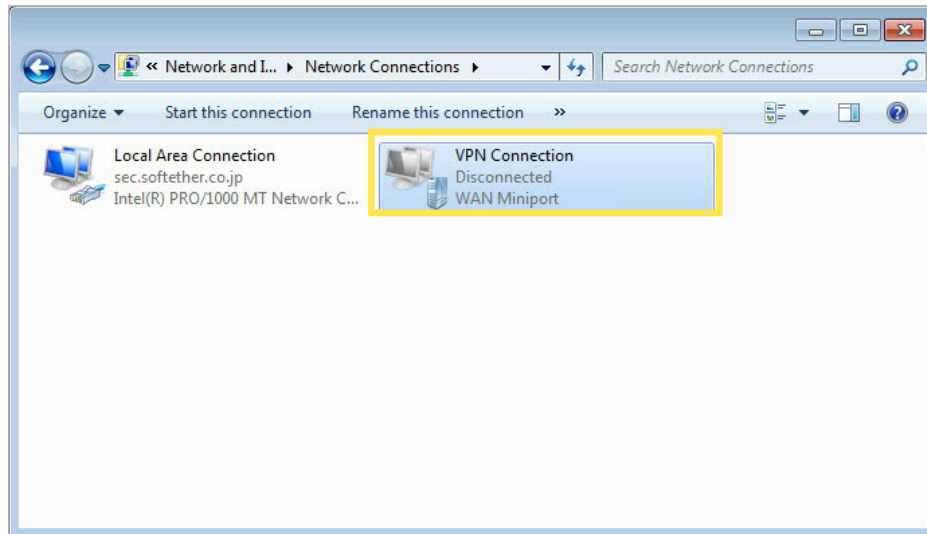

10. Enter the **User name** and **Password** you have set for the IPSec VPN server on your router, and click **Properties**.



11. Switch to the **Security** tab, select **Layer 2 Tunneling Protocol with IPsec (L2TP/IPSec)** and click **Advanced settings**.

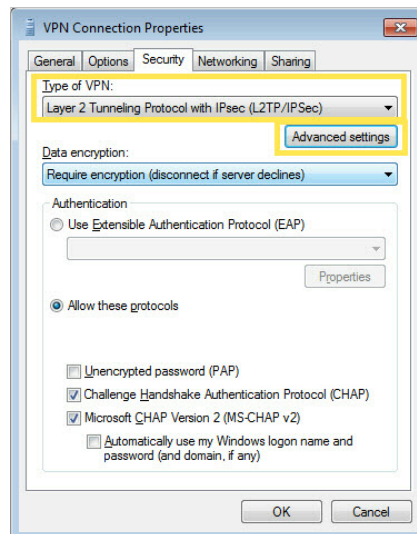

12. Select **Use preshared key for authentication** and enter the IPsec Pre-Shared Key you have set for the IPsec VPN server on your router. Then click **OK**.

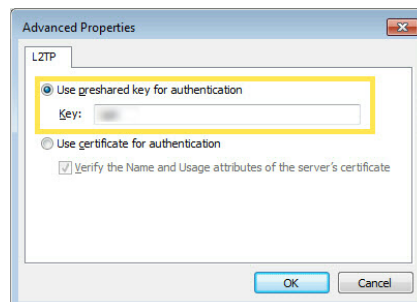

Done! Click **Connect** to start VPN connection.

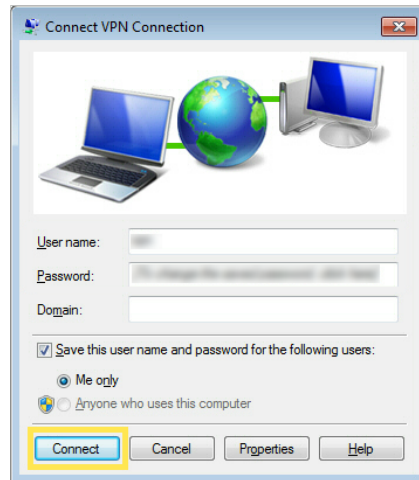

16.4. VPN Connections

VPN Connections page displays the clients that are currently connected to the OpenVPN servers, PPTP VPN servers and IPSec VPN hosted on the router.

1. Visit <http://tplinkmodem.net> or <http://192.168.1.1>, and log in with the password you set for the modem router.
2. Go to **Advanced > VPN > VPN connections**.

VPN Connections							
OpenVPN Connection							
ID	Client IP Address		Modify				
--	--		--				
PPTP VPN Connection							
ID	Client IP Address		Modify				
--	--		--				
IPSec VPN Connection							
<input type="checkbox"/>	Connection Name	Remote Gateway	Local Address	Remote Address	Status	Enable	Modify
--	--	--	--	--	--	--	--

Chapter 17

Manage Your Modem Router

This chapter introduces how to change the system settings and administrate your router's network.

This chapter contains the following sections:

- [Set System Time](#)
- [Control the LED](#)
- [Test Internet Connectivity](#)
- [Update the Firmware](#)
- [Back Up and Restore Configuration Settings](#)
- [Reboot the Modem Router](#)
- [Administration Management](#)
- [System Log](#)
- [CWMP Settings](#)
- [SNMP Settings](#)
- [Monitor the Internet Traffic Statistics](#)
- [Port Mirror](#)
- [Session Timeout](#)

17.1. Set System Time

System time is the time displayed while the router is running. The system time you configure here will be used for other time-based functions like Parental Controls and Wireless Schedule. You can manually set how to get the system time.

Follow the steps below to set your system time.

1. Visit <http://tplinkmodem.net> or <http://192.168.1.1>, and log in with the password you set for the modem router.
2. Go to [Advanced](#) > [System Tools](#) > [Time Settings](#) page.

3. Configure the system time using the following methods:
 - Get from PC:** Click this button if you want to use the current time of your PC.
 - Get from the Internet:** Click this button if you want to get time from the internet. Make sure your router can access the internet before you select this way to get system time.
4. Click [Save](#).
5. After setting the system time, you can set [Daylight Saving Time](#) according to your needs. Enable [Daylight Saving Time](#), and set the start and end time and then click [Save](#) to make the settings effective.

17.2. Control the LED

The LED of the router indicates its activities and status. You can enable the Night Mode feature to specify a time period during which the LED is off.

1. Visit <http://tplinkmodem.net> or <http://192.168.1.1>, and log in with the password you set for the modem router.
2. Go to [Advanced](#) > [System](#) > [LED Control](#).
3. Enable [Night Mode](#).
4. Specify the LED off time, and the LED will be off during this period every day.
5. Click [SAVE](#).

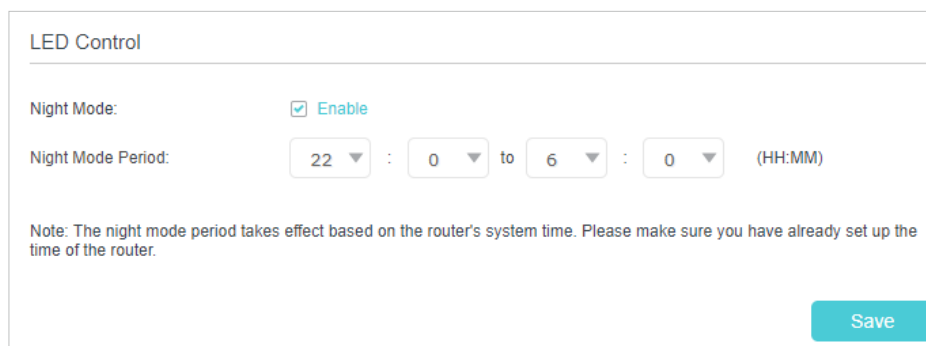

The screenshot shows the 'LED Control' configuration page. At the top, the title 'LED Control' is displayed. Below it, there is a section for 'Night Mode' with a checked checkbox and the label 'Enable'. Underneath, the 'Night Mode Period' is set to '22 : 0' to '6 : 0' (HH:MM). A note below the period settings states: 'Note: The night mode period takes effect based on the router's system time. Please make sure you have already set up the time of the router.' A 'Save' button is located at the bottom right of the form.

17.3. Test Internet Connectivity

Diagnostics function is used to test the connectivity between the router and the host or other network devices.

1. Visit <http://tplinkmodem.net> or <http://192.168.1.1>, and log in with the password you set for the modem router.
2. Go to [Advanced](#) > [System Tools](#) > [Diagnostics](#) page.

➤ **To test the internet connection of the router:**

Locate the [Diagnostic Tools](#) section, and click the [Start](#) to test the internet connectivity and you will find the test results in the gray box.

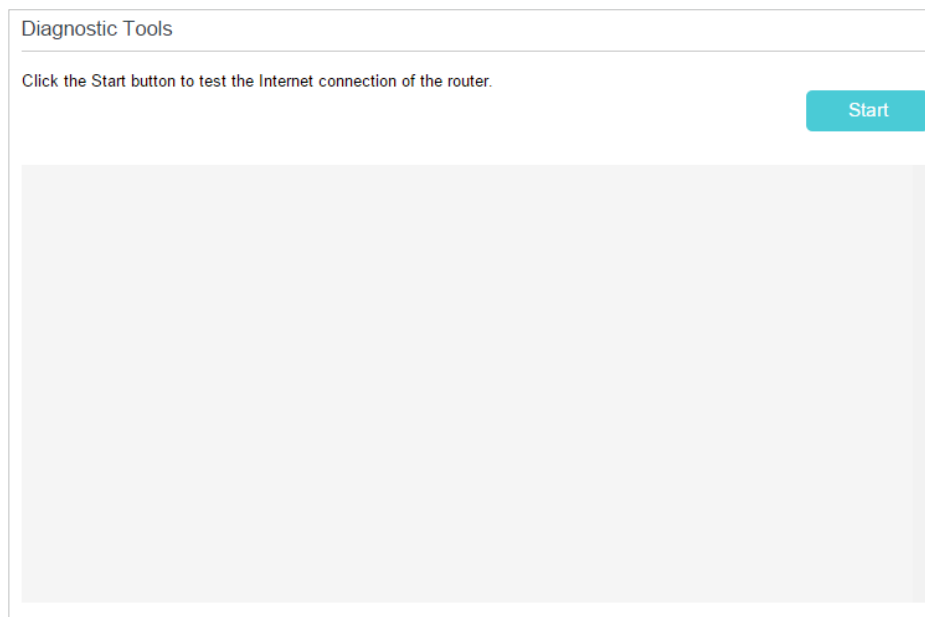

➤ **To run ping and traceroute tools:**

- 1) Locate the [Diagnostic Tools](#) section.

- 2) Select [Ping](#) or [Traceroute](#) or [Nslookup](#) as the diagnostic tool to test the connectivity.
 - [Ping](#) is used to test the connectivity between the router and the tested host, and measure the round-trip time.
 - [Traceroute](#) is used to display the route (path) your router has passed to reach the tested host, and measure transit delays of packets across an internet Protocol network.
 - [Nslookup](#) is used to queries the Domain Name System (DNS) to obtain the mapping between a domain name and IP address, or other DNS records.
- 3) Enter the [Target IP Address/Domain Name](#) of the tested host. You can change the default test options if necessary.

- 4) Click [Start](#) to begin the diagnostics, and you will find the test results in the gray box.

17.4. Update the Firmware

TP-Link is dedicated to improving product features, giving you a better network experience.

We will inform you through the web management page if there's any update firmware available for your router. The latest firmware can also be downloaded from the [Support](#) page of our website www.tp-link.com for free.

Note:

1. Make sure that you have a stable connection between the router and your computer. It is NOT recommended to upgrade the firmware wirelessly.
2. Back up your router configuration before upgrading the firmware.
3. DO NOT turn off the router during the firmware upgrade.

➤ Follow the steps below to upgrade the firmware online:

1. Click Check for Upgrades.
2. If a new firmware is displayed, click Upgrade and click Yes when prompted, then the router will automatically download the latest firmware file and upgrade.

➤ Follow the steps below to manually update the firmware:

1. Download the latest firmware file for the router from our website www.tp-link.com.
2. Visit <http://tplinkmodem.net> or <http://192.168.1.1>, and log in with the password you set for the modem router.
3. Go to [Advanced](#) > [System Tools](#) > [Firmware Upgrade](#).
4. Focus on the [Device Information](#) section. Make sure the downloaded firmware file matches with the [Hardware Version](#).

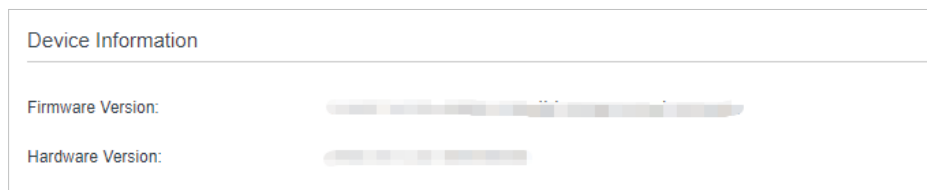

5. Focus on the [Local Upgrade](#) section. Click [Browse](#) to locate the downloaded new firmware file, and click [Upgrade](#).

Local Upgrade

-	ID	Device Name	Model Name	MAC Address	Firmware Version
<input checked="" type="checkbox"/>	1	VX230v_3266	VX230v		

New firmware file:

6. Wait a few minutes for the upgrading and rebooting.

17.5. Back Up and Restore Configuration Settings

The configuration settings are stored as a configuration file in the router. You can back up the configuration file to your computer for future use and restore the router to a previous settings from the backup file when needed. Moreover, if needed you can erase the current settings and reset the router to its default factory settings.

1. Visit <http://tplinkmodem.net> or <http://192.168.1.1>, and log in with the password you set for the modem router.
2. Go to [Advanced](#) > [System Tools](#) > [Backup & Restore](#).

➤ To back up configuration settings:

Click [Backup](#) to save a copy of the current settings to your local computer. A conf.bin file will be stored to your computer.

Backup

Save a copy of your current settings.

➤ To restore configuration settings:

- 1) Click [Browse](#) to locate the previous backup configuration file, and click [Restore](#).

Restore

Restore previous settings from a saved file.

File:

- 2) Wait a few seconds for the restoring and rebooting.

➤ To reset the router to factory default settings:

- 1) Locate the [Factory Default Restore](#) section, and click [Factory Restore](#) to reset the router.

Factory Default Restore

Restore all configuration settings to default values, except your login and cloud account information.

[Restore](#)

Restore all the configuration settings to their default values.

[Factory Restore](#)

2) Wait a few minutes for the resetting and rebooting.

Note:

1. During the resetting process, do not turn off the router.
2. We strongly recommend you back up the current configuration settings before resetting the router.

17.6. Reboot the Modem Router

The Reboot feature cleans the cache to enhance the running performance of the router. You can reboot the router manually or set it to reboot regularly.

1. Visit <http://tplinkmodem.net> or <http://192.168.1.1>, and log in with the password you set for the modem router.
2. Go to [Advanced](#) > [System Tools](#) > [Reboot Schedule](#), and you can restart your router.

➤ **To reboot the router manually:**

Click [Reboot](#), and wait a few minutes for the router to rebooting.

System Reboot

[Reboot](#)

➤ **To schedule the router to reboot at a specific time:**

- 1) Enable [Auto Reboot](#).
- 2) Specify the [Time](#) when the router reboots.

Reboot Schedule

Note: Before enabling Reboot Schedule, please make sure your router is connected to the internet. Then go to [Time Settings](#) and choose [Get from the Internet](#) to get the correct network time.

Current Time: 01/08/2016 00:10:57

Reboot Schedule: Enable

Repeat: Every day ▼

Reboot Time: 3 ▼ : 0 ▼

[Save](#)

3) Click [Save](#) to make the settings effective.

Some settings of the router may take effect only after rebooting, including:

- Change the LAN IP Address (system will reboot automatically).
- Change the Operation Mode (system will reboot automatically).
- Upgrade the firmware of the router (system will reboot automatically).
- Restore the router to its factory defaults (system will reboot automatically).
- Update the configuration with the file (system will reboot automatically).

Note:

The Auto Reboot feature takes effect based on the router's system time. Please make sure you have already set up the time of the router.

17.7. Administration Management

17.7.1. Change the Login Password

A login password is required to log in to the router's web management page. You are asked to set a login password at first login. You can change it with the account management feature.

1. Visit <http://tplinkmodem.net> or <http://192.168.1.1>, and log in with the password you set for the modem router.
2. Go to [Advanced](#) > [System Tools](#) > [Administration](#), and locate the [Account Management](#) section.

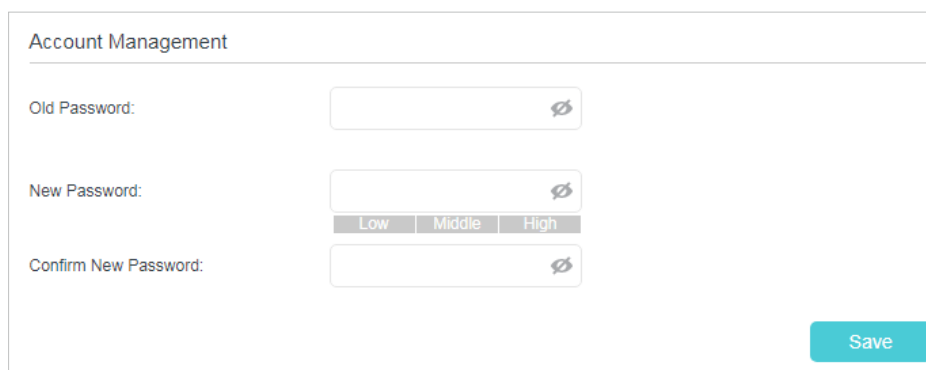

The screenshot shows the 'Account Management' section of a web interface. It contains three input fields for passwords: 'Old Password', 'New Password', and 'Confirm New Password'. Each field has a toggle icon to the right. Below the 'New Password' field, there are three radio buttons labeled 'Low', 'Middle', and 'High' for password strength selection. A blue 'Save' button is located at the bottom right of the form.

3. Enter the old password and a new password twice (both case-sensitive).
4. Click [Save](#) to make the settings effective.

17.7.2. Local Management

You can control the local devices' authority to manage the router via Local Management feature. By default all local connected devices are allowed to manage the router. You

can also specify one device to manage the router and enable local management over a more secure way, HTTPS.

Follow the steps below to allow only the specific device to manage the router via the local management over HTTPS.

1. Visit <http://tplinkmodem.net> or <http://192.168.1.1>, and log in with the password you set for the modem router.
2. Go to **Advanced > System Tools > Administration**, and locate the **Local Management** section.
3. Enable **Local Management over HTTPS** and keep the **Port for HTTP** and **Port for HTTPS** as the default settings. Enter the **IP address** or **MAC address** of the local device to manage the router.

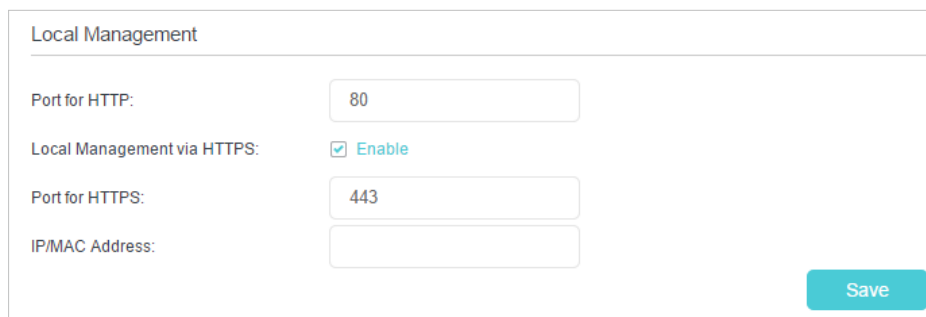

Local Management

Port for HTTP: 80

Local Management via HTTPS: Enable

Port for HTTPS: 443

IP/MAC Address:

Save

4. Click **Save**.

Now, you can manage the modem router over both HTTP (<http://tplinkmodem.net>) and HTTPS (<https://tplinkmodem.net>).

Note:

If you want all local devices can manage the router, just leave the **IP/MAC Address** field blank.

17. 7. 3. Remote Management

By default, the remote devices are not allowed to manage the router from the internet. You can enable remote management over HTTP and/or HTTPS if needed. HTTPS is a more secure way to access the router.

Note:

If your ISP assigns a private WAN IP address (such as 192.168.x.x or 10.x.x.x), you cannot use the remote management feature because private addresses are not routed on the internet.

Follow the steps below to allow remote devices to manage the router over HTTPS.

1. Visit <http://tplinkmodem.net> or <http://192.168.1.1>, and log in with the password you set for the modem router.
2. Go to **Advanced > System Tools > Administration**, and locate the **Remote Management** section.

3. Enable [Remote Management](#) and [Remote Management via HTTPS](#) to allow for HTTPS connection. Keep the [Port](#) as the default setting.
4. Set the client device allowed for remote management. Select [All](#) to allow all remote devices to manage the router. If you just want to allow a specific device to manage the router, select [Only the Following IP/MAC Address](#) and enter the IP/MAC address of the remote device.
5. Click [Save](#).

All devices or the specific device on the internet can log in to your router using the address displayed on the [Manage This Router via the Address](#) field to manage the router.

Tips:

1. If you were warned about the certificate when visiting the web management page remotely, click [Trust](#) (or a similar option) to continue. To avoid this warning, you can download and install the certificate on the router's web management page at [Advanced > System Tools > Administration](#).

2. The router's WAN IP is usually a dynamic IP. Please refer to [Set Up a Dynamic DNS Service Account](#) if you want to log in to the router through a domain name.

17. 7. 4. HTTP Referrer Head Check

HTTP referer header check function can protect your networks against CSRF attacks. This function is enabled by default. You can disable this function if needed.

1. Visit <http://tplinkmodem.net> or <http://192.168.1.1>, and log in with the password you set for the modem router.
2. Go to **Advanced** > **System Tools** > **Administration**, and locate the **HTTP Referer Head Check** section.
3. Clear the **Enable** check box and click **Save** if you want to disable this function.

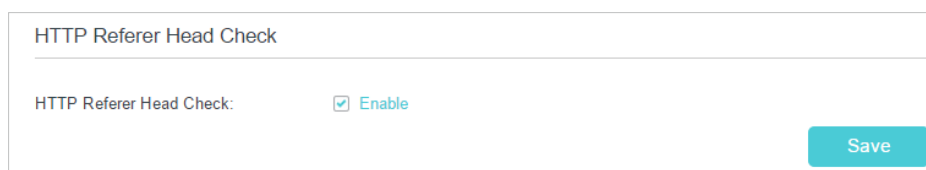

HTTP Referer Head Check

HTTP Referer Head Check: Enable

Save

17.7.5. ICMP Ping

ICMP (Internet Control Message Protocol) Ping is used to diagnose the network by sending ICMP echo request packets to the target remote or local host and waiting for an ICMP response.

You can control the router's replies to ICMP Ping requests.

1. Visit <http://tplinkmodem.net> or <http://192.168.1.1>, and log in with the password you set for the modem router.
2. Go to **Advanced** > **System Tools** > **Administration**, and locate the **ICMP Ping** section.

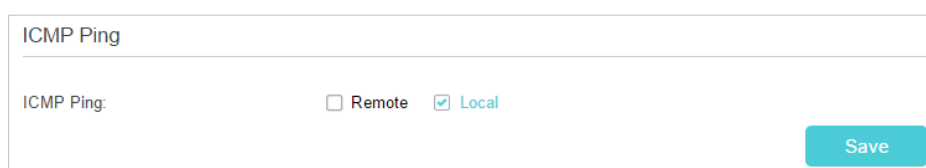

ICMP Ping

ICMP Ping: Remote Local

Save

3. Specify the ICMP Ping reply options.
 - **Remote:** Select it if you want the computers on a public network to ping the router's WAN IP address.
 - **Local:** Enabled by default, if enabled, the computers on a private network can ping the router's LAN IP address.
4. Click **Save** to make the settings effective.

17.7.6. Session ID

When Session ID function is enabled, it will be saved into Flash every time the PPP connection is updated. This can prevent some problems of PPPoE/L2TP/PPTP connection being rejected to reconnect to servers when the device is powered off or the network disconnect accidentally.

1. Visit <http://tplinkmodem.net> or <http://192.168.1.1>, and log in with the password you set for the modem router.
2. Go to [Advanced](#) > [System Tools](#) > [Administration](#), and locate the [Session ID](#) section.

Session ID

Update Session ID: Enable

Save

3. Enable the [Update Session ID](#) and Click [Save](#) to make the settings effective.

17.8. System Log

System Log can help you know what happened to your router, facilitating you to locate the malfunctions. For example when your router does not work properly, you may need to save the system log and send it to the technical support for troubleshooting.

1. Visit <http://tplinkmodem.net> or <http://192.168.1.1>, and log in with the password you set for the modem router.
2. Go to [Advanced](#) > [System Tools](#) > [System Log](#) page.

System Log

Type: ALL

Level: Notice

Refresh Delete All

ID	Time	Type	Level	Log Content
1	2016-01-01 02:43:34	HTTPD	Notice	Clear log.

Log Settings Save Log

➤ To view the system logs:

You can view specific system logs by selecting the log type and level.

Click [Refresh](#) to refresh the log list.

➤ To save the system logs:

You can save the system logs to your local computer or a remote server.

Click [Save Log](#) to save the logs in a txt file to your computer.

Click [Log Settings](#) to set the storage path of logs.

Log Settings

Save Locally

Minimum Level: Information

Save Remotely

Minimum Level: Warning

Server IP: 192.168.1.100

Server Port: 514

Local Facility Name: User

Back Save

- **Save Locally:** Select this option to cache the system log to the router's local memory, select the minimum level of system log to be saved from the drop-down list. The logs will be shown in the table in descending order on the System Log page.
- **Save Remotely:** Select this option to send the system log to a remote server, select the minimum level of system log to be saved from the drop-down list and enter the information of the remote server. If the remote server has a log viewer client or a sniffer tool implemented, you can view and analyze the system log remotely in real-time.

17.9. CWMP Settings

The router supports CWMP (CPE WAN Management Protocol), also called TR-069. This collects information, performs diagnostics and configures the devices automatically via ACS (Auto-Configuration Server).

1. Visit <http://tplinkmodem.net> or <http://192.168.1.1>, and log in with the password you set for the modem router.
2. Go to [Advanced](#) > [System Tools](#) > [CWMP Settings](#) page.

CWMP Settings

CPE WAN Management Protocol (also called TR-069) allows Auto-Configuration Server (ACS) to perform auto-configuration, provision, connection, and diagnostics to this device. You may configure this function under your ISP's instructions.

CWMP:

Inform:

Inform DataModel with TR098:

Inform Interval:

ACS URL:

ACS Username:

ACS Password:

Interface used by TR-069 client:

CPE ID: SN LAN MAC WAN MAC

Connection Request Authentication

Username:

Password:

Path: Manual Random

Port:

URL:

Simple Traversal of UDP over NATs:

- **CWMP:** Enable or disable the CWMP (CPE WAN Management Protocol) function.
- **Inform:** Enable or disable the function of sending an inform message to the ACS (Auto Configuration Server) periodically.
- **Inform Interval:** Set the time interval in seconds when the Inform message will be sent to the ACS.
- **ACS URL:** Enter the web address of the ACS which is provided by your ISP.
- **ACS Username/Password:** Enter the username/password to log in to the ACS server.
- **Interface used by TR-069 client:** Select which interface to be used by the TR-069 client.
- **Display SOAP messages on serial console:** Enable or disable this function.
- **Connection Request Authentication:** Select this check box to enable authentication for the connection request.
- **Username/Password:** Enter the username/password for the ACS server to log in to the router.

- **Path:** Enter the path for the ACS server to log in to the router.
- **Port:** Enter the port that connects to the ACS server.
- **URL:** Enter the URL that connects to the ACS server.
- **Simple Traversal of UDP over NATs:** Select this check box to enable STUN for the connection request and set the STUN maximum and minimum keep alive period, server address and port.

Click **Save** to make the settings effective.

17. 10. SNMP Settings

SNMP (Simple Network Management Protocol) is widely used in network management for network monitoring. It allows management applications to retrieve status updates and statistics from the SNMP agent within this device. In this way, network administrators can easily search and modify the information on any node on the network. Meanwhile, they can locate faults promptly and implement the fault diagnosis, capacity planning and report generating.

The **SNMP Agent** is an application running on the router that performs the operational role of receiving and processing SNMP messages, sending responses to the SNMP manager, and sending traps when an event occurs. So a router contains SNMP “agent” software can be monitored and/or controlled by SNMP Manager using SNMP messages.

1. Visit <http://tplinkmodem.net> or <http://192.168.1.1>, and log in with the password you set for the modem router.
2. Go to **Advanced > System Tools > SNMP Settings** page.

SNMP Settings

Simple Network Management Protocol (SNMP) allows management applications to retrieve status updates and statistics from the SNMP agent within this device.

Enable SNMP Agent:

SNMP Agent for WAN:

Read-only Community:

Write Community:

System Name:

System Description:

System Location:

System Contact:

Trap Manager IP:

Save

- **SNMP Agent/SNMP Agent for WAN:** Turn on to enable the built-in SNMP agent that allows the router to operate as the operational role in receiving and processing of SNMP messages, sending responses to the SNMP manager, and triggering SNMP traps when an event occurs.
- **Read-only Community:** Displays the default public community string that protects the router from unauthorized access.
- **Write Community:** Displays the default write community string that protects the router from unauthorized changes.
- **System Name:** Displays the administratively-assigned name for this managed device.
- **System Description:** Displays the textual description of the managed device. This value should include the full name and version identification of the system's hardware type, software operating-system, and networking software.
- **System Location:** Displays the physical location of this device (for example, the telephone closet, 3rd floor).
- **System Contact:** Displays the textual identification of the contact person for this managed device, together with information on how to contact this person.
- **Trap Manager IP:** Displays the IP address of the host to receive the traps.

You are suggested to keep the default settings. Click **Save** to make the settings effective.

17. 11. Monitor the Internet Traffic Statistics

The traffic statistics function allows you to monitor the volume of internet traffic statistics. You can view the network traffic of the LAN, WAN and WLAN sent and received packets.

1. Visit <http://tplinkmodem.net> or <http://192.168.1.1>, and log in with the password you set for the modem router.
2. Go to **Advanced > System Tools > Traffic Statistics**.
3. Turn on **Enable Traffic Statistics** to enable traffic statistics function, you can view the total number of packets and bytes received and transmitted by the router within the selected **Statistics Interval**. This function is disabled by default.

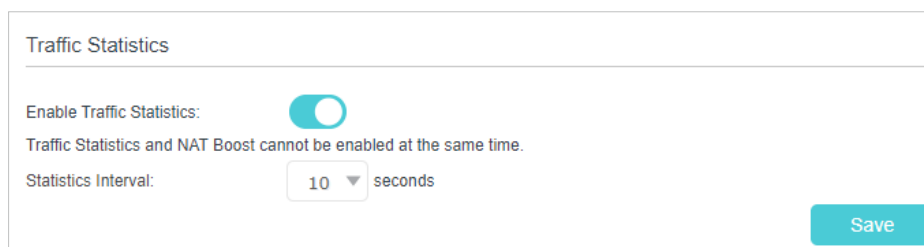

Traffic Statistics

Enable Traffic Statistics:

Traffic Statistics and NAT Boost cannot be enabled at the same time.

Statistics Interval: 10 seconds

Save

4. You can refer to [Traffic Statistics List](#) for the detailed information about the traffic usage of all devices.

Traffic Statistics List								
IP Address/ MAC Address	Total Packets	Total Bytes	Current Packets	Current Bytes	Current ICMP Tx	Current UDP Tx	Current SYN Tx	Modify
--	--	--	--	--	--	--	--	--

17.12. Port Mirror

This feature copies network packets of the WAN port to a specific LAN port for data analysis and network monitoring.

1. Visit <http://tplinkmodem.net> or <http://192.168.1.1>, and log in with the password you set for the modem router.
2. Go to [Advanced](#) > [System Tools](#) > [Port Mirror](#)

Port Mirror	
Enable:	<input checked="" type="checkbox"/> Enable
Lan Interface:	LAN1
Wan Interface:	DSL PORT
Timeout:	0 (seconds)
Save	

3. Enable Port Mirroring.
4. Select a LAN port to mirror network packets of the WAN port.
5. Set a Timeout duration after which Port Mirroring will disable automatically. If you set Timeout to 0 seconds, Port Mirroring will not disable automatically.
6. Save the settings.

17.13. Session Timeout

This page allows you to set the session timeout for system connection.

1. Visit <http://tplinkmodem.net> or <http://192.168.1.1>, and log in with the password you set for the modem router.
2. Go to [Advanced](#) > [System Tools](#) > [Session Timeout](#)

Session Timeout Settings

Enable Session Timeout Settings:

TCP Session Timeout: (seconds)

UDP Session Timeout: (seconds)

UDP Stream Timeout: (seconds)

3. Enable [Session Timeout Settings](#) feature.

- **TCP Session Timeout:** After the specified time, if the established TCP connection is not active, the connection will be cleared. The default value is 432000 seconds.
- **UDP Session Timeout:** After the specified time, if the UDP connection does not respond, the connection will be cleared. The default value is 30 seconds.
- **UDP Stream Timeout:** After the specified time, for the established UDP streams, the connections will be cleared. The default value is 180 seconds.

FAQ

Q1. What should I do if I forget my wireless password?

The default wireless password is printed on the label of the router. If the password has been altered:

1. Connect your computer to the router using an Ethernet cable.
2. Visit <http://tplinkmodem.net> or <http://192.168.1.1>, and log in with the password you set for the modem router.
3. Go to [Wireless](#) to retrieve or reset your wireless password.

Q2. What should I do if I forget my web management password?

- If you are using a TP-Link ID to log in, or you have enabled the Password Recovery feature of the router, click [Forgot password](#) on the login page and then follow the instructions to reset it.
- Alternatively, press and hold the [Reset](#) button of the router until the Power LED blinks to restore factory default settings, and then visit <http://tplinkmodem.net> or <http://192.168.1.1> to create a new login password.

Note:

- You'll need to reconfigure the router to surf the internet once the router is reset, and please mark down your new password for future use.

Q3. What should I do if I can't log in to the router's web management page?

This can happen for a variety of reasons. Please try the methods below to log in again.

- Make sure your computer is connected to the router correctly and the corresponding LED indicator(s) light up.
- Make sure the IP address of your computer is configured as [Obtain an IP address automatically](#) and [Obtain DNS server address automatically](#).
- Make sure <http://tplinkmodem.net> or <http://192.168.1.1> is correctly entered.
- Check your computer's settings:
 - 1) Go to [Start](#) > [Control Panel](#) > [Network and Internet](#), and click [View network status and tasks](#).
 - 2) Click [Internet Options](#) on the bottom left.
 - 3) Click [Connections](#) and select [Never dial a connection](#).

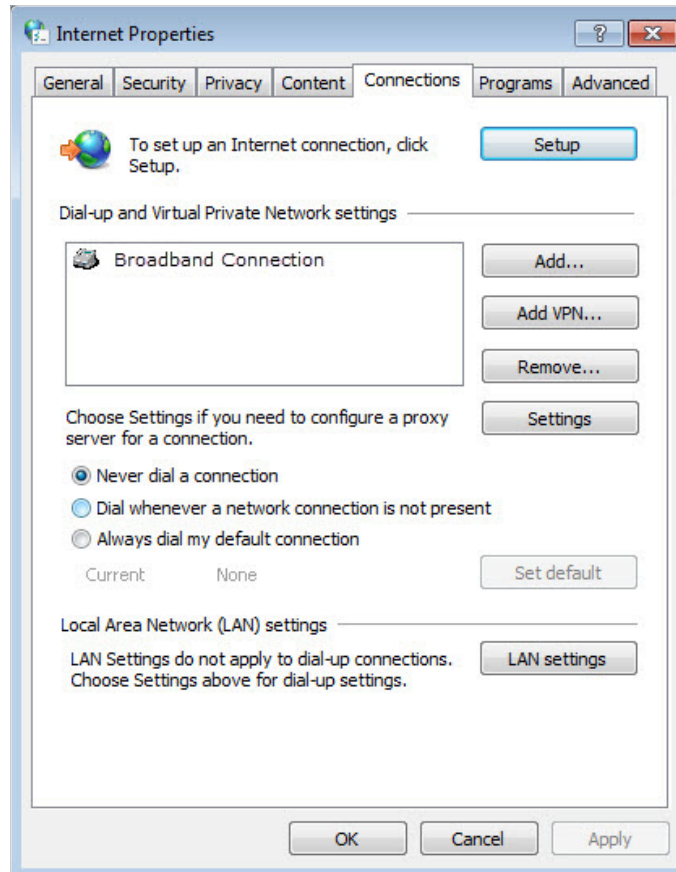

4) Click [LAN settings](#) and deselect the following three options and click [OK](#).

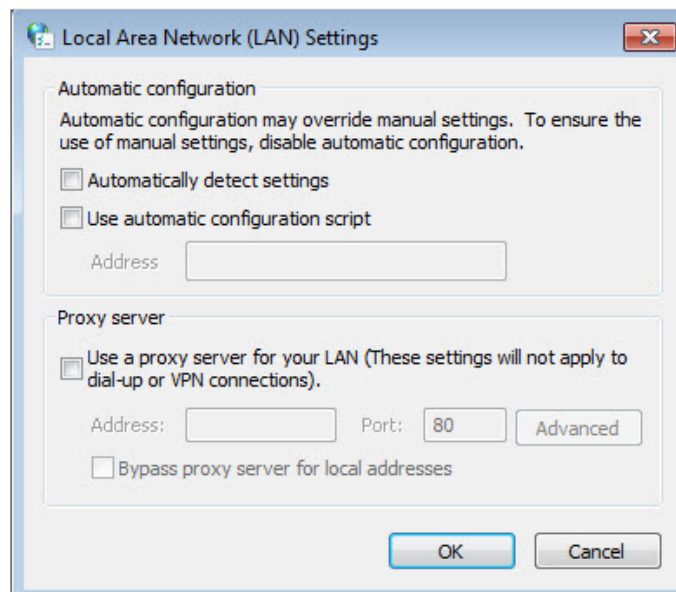

5) Go to [Advanced](#) > [Restore advanced settings](#), click [OK](#) to save the settings.

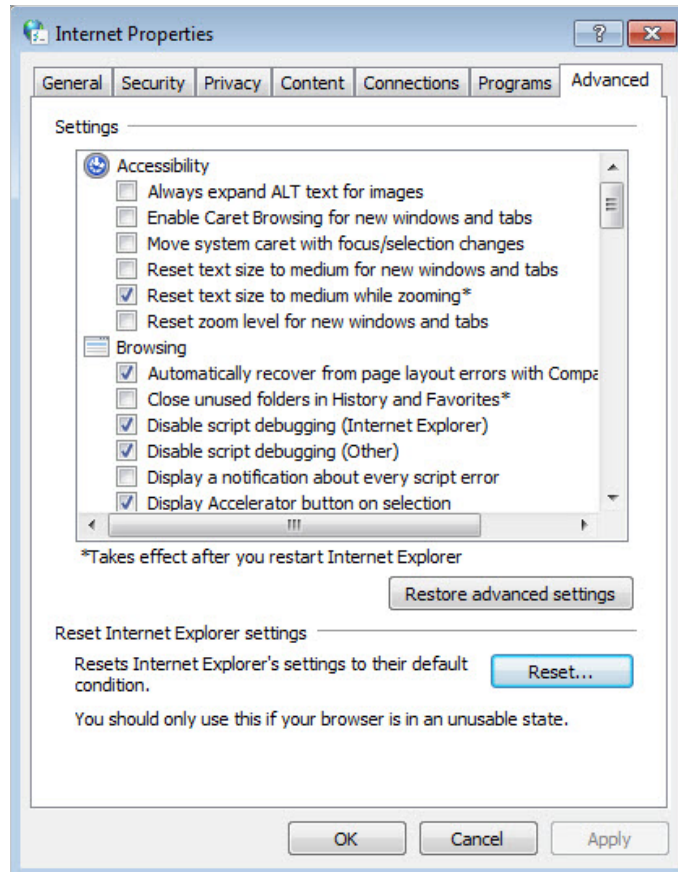

- Use another web browser or computer to log in again.
- Reset the router to factory default settings and try again. If login still fails, please contact the technical support.

ⓘ Note: You'll need to reconfigure the router to surf the internet once the router is reset.

Q4. What should I do if I can't access the internet even though the configuration is finished?

1. Visit <http://tplinkmodem.net> or <http://192.168.1.1>, and log in with the password you set for the modem router.
2. Go to **Advanced > Network > Status** to check internet status:

If IP Address is a valid one, please try the methods below and try again:

- Your computer might not recognize any DNS server addresses. Please manually configure the DNS server.
 - 1) Go to **Advanced > Network > LAN Settings**.
 - 2) Enter 8.8.8.8 as Primary DNS, click **SAVE**.

💡 Tips: 8.8.8.8 is a safe and public DNS server operated by Google.

DHCP:	<input checked="" type="checkbox"/> Enable
	<input checked="" type="radio"/> DHCP Server <input type="radio"/> DHCP Relay
IP Address Pool:	192 . 168 . 1 . 100 - 192 . 168 . 1 . 249
Address Lease Time:	120 minutes. (1-2880. The default value is 1440.)
Default Gateway:	0 . 0 . 0 . 0 (Optional)
Default Domain:	(Optional)
Primary DNS:	8 . 8 . 8 . 8 (Optional)
Secondary DNS:	0 . 0 . 0 . 0 (Optional)

[Save](#)

- Restart the modem and the router.
 - 1) Power off your modem and router, and leave them off for 1 minute.
 - 2) Power on your modem first, and wait about 2 minutes until it gets a solid cable or Internet light.
 - 3) Power on the router.
 - 4) Wait another 1 or 2 minutes and check the internet access.
- Reset the router to factory default settings and reconfigure the router.
- Upgrade the firmware of the router.
- Check the TCP/IP settings on the particular device if all other devices can get internet from the router.

As the picture below shows, if the IP Address is 0.0.0.0, please try the methods below and try again:

Status

Internet status overview is displayed on this page.

Internet

Status: WAN port is unplugged

Internet Connection Type: Dynamic IP

IP Address: 0.0.0.0

Subnet Mask: 0.0.0.0

Default Gateway: 0.0.0.0

Primary DNS: 0.0.0.0

Secondary DNS: 0.0.0.0

- Make sure the physical connection between the router and the modem is proper.
- Clone the MAC address of your computer.

- 1) Visit <http://tplinkmodem.net> or <http://192.168.1.1>, and log in with the password you set for the modem router.
- 2) Go to [Internet](#) or [Advanced](#) > [Network](#) > [Internet](#) and focus on the [MAC Clone](#) section.
- 3) Choose an option as needed (enter the MAC address if [Use Custom MAC Address](#) is selected), and click [SAVE](#).

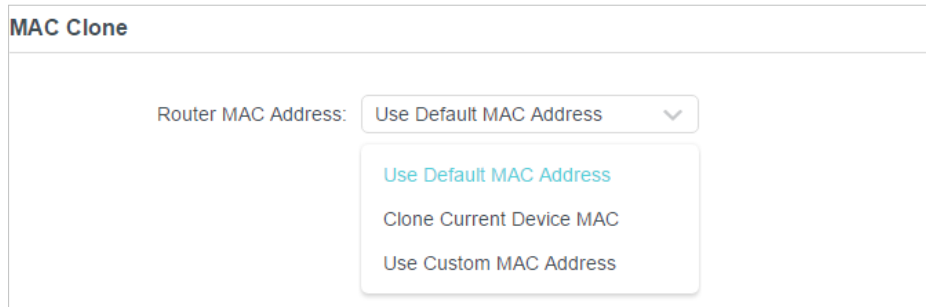

MAC Clone

Router MAC Address:

- Use Default MAC Address
- Clone Current Device MAC
- Use Custom MAC Address

 **Tips:**

- Some ISP will register the MAC address of your computer when you access the internet for the first time through their Cable modem, if you add a router into your network to share your internet connection, the ISP will not accept it as the MAC address is changed, so we need to clone your computer's MAC address to the router.
- The MAC addresses of a computer in wired connection and wireless connection are different.

- **Modify the LAN IP address of the router.**

 **Note:**

Most TP-Link routers use 192.168.0.1/192.168.1.1 as their default LAN IP address, which may conflict with the IP range of your existing ADSL modem/router. If so, the router is not able to communicate with your modem and you can't access the internet. To resolve this problem, we need to change the LAN IP address of the router to avoid such conflict, for example, 192.168.2.1.

- 1) Visit <http://tplinkmodem.net> or <http://192.168.1.1>, and log in with the password you set for the modem router.
- 2) Go to [Advanced](#) > [Network](#) > [LAN](#).
- 3) Modify the LAN IP address as the follow picture shows. Here we take 192.168.2.1 as an example.
- 4) Click [Save](#).



LAN

View and configure LAN settings.

MAC Address: 98-DA-C4-B4-01-D8

IP Address:

Subnet Mask:

- Restart the modem and the router.

- 1) Power off your modem and router, and leave them off for 1 minute.
 - 2) Power on your modem first, and wait about 2 minutes until it get a solid cable or Internet light.
 - 3) Power on the router.
 - 4) Wait another 1 or 2 minutes and check the internet access.
- Double check the internet connection type.
 - 1) Confirm your internet connection type, which can be learned from the ISP.
 - 2) Visit <http://tplinkmodem.net> or <http://192.168.1.1>, and log in with the password you set for the modem router.
 - 3) Go to [Advanced](#) > [Network](#) > [Internet](#).
 - 4) Select your [Internet Connection Type](#) and fill in other parameters.
 - 5) Click [Save](#).

Internet

Set up an internet connection with the service information provided by your ISP (internet service provider).

Internet Connection Type: Dynamic IP ▼

IP Address: Static IP

Subnet Mask: Dynamic IP

Default Gateway: PPPoE

Primary DNS: L2TP

Secondary DNS: PPTP

Secondary DNS: 0.0.0.0

RENEW
RELEASE

- 6) Restart the modem and the router again.
- Please upgrade the firmware of the router.
- If you've tried every method above but still cannot access the internet, please contact the technical support.

Q5. What should I do if I can't find my wireless network or I cannot connect the wireless network?

If you fail to find any wireless network, please follow the steps below:

- Make sure the wireless function of your device is enabled if you're using a laptop with built-in wireless adapter. You can refer to the relevant document or contact the laptop manufacturer.

- Make sure the wireless adapter driver is installed successfully and the wireless adapter is enabled.

- **On Windows 7**

- 1) If you see the message [No connections are available](#), it is usually because the wireless function is disabled or blocked somehow.
- 2) Click [Troubleshoot](#) and windows might be able to fix the problem by itself.

- **On Windows XP**

- 1) If you see the message [Windows cannot configure this wireless connection](#), this is usually because windows configuration utility is disabled or you are running another wireless configuration tool to connect the wireless.
- 2) Exit the wireless configuration tool (the TP-Link Utility, for example).
- 3) Select and right click on [My Computer](#) on desktop, select [Manage](#) to open Computer Management window.
- 4) Expand [Services and Applications](#) > [Services](#), find and locate [Wireless Zero Configuration](#) in the Services list on the right side.
- 5) Right click [Wireless Zero Configuration](#), and then select [Properties](#).
- 6) Change [Startup type](#) to [Automatic](#), click on Start button and make sure the Service status is [Started](#). And then click [OK](#).

If you can find other wireless network except your own, please follow the steps below:

- Check the WLAN LED indicator on your wireless router/modem.
- Make sure your computer/device is still in the range of your router/modem. Move it closer if it is currently too far away.
- Go to [Wireless](#) or [Advanced](#) > [Wireless](#) > [Wireless Settings](#), and check the wireless settings. Double check your wireless Network Name and SSID is not hidid.

If you can find your wireless network but fail to connect, please follow the steps below:

- **Authenticating problem/password mismatch:**

- 1) Sometimes you will be asked to type in a PIN number when you connect to the wireless network for the first time. This PIN number is different from the Wireless Password/Network Security Key, usually you can only find it on the label of your router.



- 2) If you cannot find the PIN or PIN failed, you may choose [Connecting using a security key instead](#), and then type in the [Wireless Password/Network Security Key](#).
- 3) If it continues to show note of [Network Security Key Mismatch](#), it is suggested to confirm the wireless password of your wireless router.

Note: Wireless Password/Network Security Key is case sensitive.

- **Windows unable to connect to XXXX / Can not join this network / Taking longer than usual to connect to this network:**
 - Check the wireless signal strength of your network. If it is weak (1~3 bars), please move the router closer and try again.
 - Change the wireless Channel of the router to 1, 6 or 11 to reduce interference from other networks.
 - Re-install or update the driver for your wireless adapter of the computer.

FCC compliance information statement



Product Name: AX1800 Dual-Band Wi-Fi 6 VDSL/ADSL Modem Router

Model Number: VX230v

Component Name	Model
I.T.E. Power	T120200-2B1

Responsible party:

TP-Link USA Corporation

Address: 10 Mauchly, Irvine, CA 92618

Website: <http://www.tp-link.com/us/>

Tel: +1 626 333 0234

Fax: +1 909 527 6804

E-mail: sales.usa@tp-link.com

This equipment has been tested and found to comply with the limits for a Class B digital device, pursuant to part 15 of the FCC Rules. These limits are designed to provide reasonable protection against harmful interference in a residential installation. This equipment generates, uses and can radiate radio frequency energy and, if not installed and used in accordance with the instructions, may cause harmful interference to radio communications. However, there is no guarantee that interference will not occur in a particular installation. If this equipment does cause harmful interference to radio or television reception, which can be determined by turning the equipment off and on, the user is encouraged to try to correct the interference by one or more of the following measures:

- Reorient or relocate the receiving antenna.
- Increase the separation between the equipment and receiver.
- Connect the equipment into an outlet on a circuit different from that to which the receiver is connected.
- Consult the dealer or an experienced radio/ TV technician for help.

This device complies with part 15 of the FCC Rules. Operation is subject to the following two conditions:

1. This device may not cause harmful interference.
2. This device must accept any interference received, including interference that may cause undesired operation.

Any changes or modifications not expressly approved by the party responsible for compliance could void the user's authority to operate the equipment.

Note: The manufacturer is not responsible for any radio or TV interference caused by unauthorized modifications to this equipment. Such modifications could void the user's authority to operate the equipment.

FCC RF Radiation Exposure Statement

This equipment complies with FCC RF radiation exposure limits set forth for an uncontrolled environment. This device and its antenna must not be co-located or operating in conjunction with any other antenna or transmitter.

To comply with FCC RF exposure compliance requirements, this grant is applicable to only Mobile Configurations. The antennas used for this transmitter must be installed to provide a separation distance of at least 23 cm from all persons and must not be co-located or operating in conjunction with any other antenna or transmitter.

We, **TP-Link USA Corporation**, has determined that the equipment shown as above has been shown to comply with the applicable technical standards, FCC part 15. There is no unauthorized change is made in the equipment and the equipment is properly maintained and operated.

Issue Date: 2022.11.03

FCC compliance information statement

Product Name: I.T.E. Power Supply

Model Number: T120200-2B1

Responsible party:

TP-Link USA Corporation

Address: 10 Mauchly, Irvine, CA 92618

Website: <http://www.tp-link.com/us/>

Tel: +1 626 333 0234

Fax: +1 909 527 6804

E-mail: sales.usa@tp-link.com

This equipment has been tested and found to comply with the limits for a Class B digital device, pursuant to part 15 of the FCC Rules. These limits are designed to provide reasonable protection against harmful interference in a residential installation. This equipment generates, uses and can radiate radio frequency energy and, if not installed and used in accordance with the instructions, may cause harmful interference to radio communications. However, there is no guarantee that interference will not occur in a particular installation. If this equipment does cause harmful interference to radio or television reception, which can be determined by turning the equipment off and on, the user is encouraged to try to correct the interference by one or more of the following measures:

- Reorient or relocate the receiving antenna.
- Increase the separation between the equipment and receiver.
- Connect the equipment into an outlet on a circuit different from that to which the receiver is connected.
- Consult the dealer or an experienced radio/ TV technician for help.

This device complies with part 15 of the FCC Rules. Operation is subject to the following two conditions:

1. This device may not cause harmful interference.
2. This device must accept any interference received, including interference that may cause undesired operation.

Any changes or modifications not expressly approved by the party responsible for compliance could void the user's authority to operate the equipment.

We, **TP-Link USA Corporation**, has determined that the equipment shown as above has been shown to comply with the applicable technical standards, FCC part 15. There is no unauthorized change is made in the equipment and the equipment is properly maintained and operated.

Issue Date: 2022.11.03

Canadian Compliance Statement

This device contains licence-exempt transmitter(s)/receiver(s) that comply with Innovation, Science and Economic Development Canada's licence-exempt RSS(s). Operation is subject to the following two conditions:

1. This device may not cause interference.
2. This device must accept any interference, including interference that may cause undesired operation of the device.

L'émetteur/récepteur exempt de licence contenu dans le présent appareil est conforme aux CNR d'Innovation, Sciences et Développement économique Canada applicables aux appareils radio exempts de licence. L'exploitation est autorisée aux deux conditions suivantes :

1. l'appareil ne doit pas produire de brouillage;
2. l'utilisateur de l'appareil doit accepter tout brouillage radioélectrique subi, même si le brouillage est susceptible d'en compromettre le fonctionnement

Caution:

The device for operation in the band 5150–5250 MHz is only for indoor use to reduce the potential for harmful interference to co-channel mobile satellite systems;

DFS (Dynamic Frequency Selection) products that operate in the bands 5250-5350 MHz, 5470-5600MHz, and 5650-5725MHz.

Avertissement:

Le dispositif fonctionnant dans la bande 5150-5250 MHz est réservé uniquement pour une utilisation à l'intérieur afin de réduire les risques de brouillage préjudiciable aux systèmes de satellites mobiles utilisant les mêmes canaux;

Les produits utilisant la technique d'atténuation DFS (sélection dynamique des fréquences) sur les bandes 5250- 5350 MHz, 5470-5600MHz et 5650-5725MHz.

Radiation Exposure Statement:

This equipment complies with IC radiation exposure limits set forth for an uncontrolled environment. This equipment should be installed and operated with minimum distance 20cm between the radiator & your body.

Déclaration d'exposition aux radiations:

Cet équipement est conforme aux limites d'exposition aux rayonnements IC établies pour un environnement non contrôlé. Cet équipement doit être installé et utilisé avec un minimum de 20 cm de distance entre la source de rayonnement et votre corps.

Industry Canada Statement

CAN ICES-3 (B)/NMB-3(B)

NCC Notice & BSMI Notice:

注意!

取得審驗證明之低功率射頻器材，非經核准，公司、商號或使用者均不得擅自變更頻率、加大功率或變更原設計之特性及功能。

低功率射頻器材之使用不得影響飛航安全及干擾合法通信；經發現有干擾現象時，應立即停用，並改善至無干擾時方得繼續使用。

前述合法通信，指依電信管理法規定作業之無線電通信。

低功率射頻器材須忍受合法通信或工業、科學及醫療用電波輻射性電機設備之干擾。

應避免影響附近雷達系統之操作。

高增益指向性天線只得應用於固定式點對點系統。

安全諮詢及注意事項

- 安全諮詢及注意事項
- 請使用原裝電源供應器或只能按照本產品注明的電源類型使用本產品。
- 清潔本產品之前請先拔掉電源線。請勿使用液體、噴霧清潔劑或濕布進行清潔。
- 注意防潮，請勿將水或其他液體潑灑到本產品上。
- 插槽與開口供通風使用，以確保本產品的操作可靠並防止過熱，請勿堵塞或覆蓋開口。
- 請勿將本產品置放於靠近熱源的地方。除非有正常的通風，否則不可放在密閉位置中。
- 不要私自拆開機殼或自行維修，如產品有故障請與原廠或代理商聯繫。

限用物質含有情況標示聲明書

設備名稱：AX1800 Dual-Band Wi-Fi 6 VDSL/ADSL Modem Router Equipment name		型號（型式）：VX230v Type designation (Type)				
單元 Unit	限用物質及其化學符號 Restricted substances and its chemical symbols					
	鉛 Lead (Pb)	汞 Mercury (Hg)	鎘 Cadmium (Cd)	六價鉻 Hexavalent chromium (Cr ⁺⁶)	多溴聯苯 Polybrominated biphenyls (PBB)	多溴二苯醚 Polybrominated diphenyl ethers (PBDE)
PCB	○	○	○	○	○	○
外殼	○	○	○	○	○	○
電源供應器	—	○	○	○	○	○



天線	○	○	○	○	○	○
<p>備考1. “超出0.1 wt %” 及 “超出0.01 wt %” 係指限用物質之百分比含量超出百分比含量基準值 Note 1: “Exceeding 0.1 wt %” and “exceeding 0.01 wt %” indicate that the percentage content of the restricted substance exceeds the reference percentage value of presence condition.</p> <p>備考2. “○” 係指該項限用物質之百分比含量未超出百分比含量基準值。 Note 2: “○” indicates that the percentage content of the restricted substance does not exceed the percentage of reference value of presence.</p> <p>備考3. “—” 係指該項限用物質為排除項目。 Note 3: The “—” indicates that the restricted substance corresponds to the exemption.</p>						







Safety Information

- Keep the device away from water, fire, humidity or hot environments.
- Do not attempt to disassemble, repair, or modify the device. If you need service, please contact us.
- Do not use damaged charger or USB cable to charge the device.
- Do not use any other chargers than those recommended
- Do not use the device where wireless devices are not allowed.
- Adapter shall be installed near the equipment and shall be easily accessible.
- Use only power supplies which are provided by manufacturer and in the original packing of this product. If you have any questions, please don't hesitate to contact us.
- This product uses radios and other components that emit electromagnetic fields. Electromagnetic fields and magnets may interfere with pacemakers and other implanted medical devices. Always keep the product and its power adapter more than 15 cm (6 inches) away from any pacemakers or other implanted medical devices. If you suspect your product is interfering with your pacemaker or any other implanted medical device, turn off your product and consult your physician for information specific to your medical device.
- Operating Temperature: 0°C~40°C

Please read and follow the above safety information when operating the device. We cannot guarantee that no accidents or damage will occur due to improper use of the device. Please use this product with care and operate at your own risk.

Explanations of the symbols on the product label

Symbol	Explanation
	DC voltage
	AC voltage
	Class II equipment

Symbol	Explanation
	Polarity of output terminals
	Energy efficiency Marking
	Indoor use only
	Caution
	Operator's manual
	<p>RECYCLING</p> <p>This product bears the selective sorting symbol for Waste electrical and electronic equipment (WEEE). This means that this product must be handled pursuant to European directive 2012/19/ EU in order to be recycled or dismantled to minimize its impact on the environment.</p> <p>User has the choice to give his product to a competent recycling organization or to the retailer when he buys a new electrical or electronic equipment.</p>